

Etanchéité à l'eau* EN 1027 - EN 12208

Classe
Obtenu



Pression air	0 Pa	50 Pa	100 Pa	150 Pa	200 Pa	250 Pa	300 Pa	450 Pa	600 Pa	750 Pa	900 Pa	1050 Pa	1200 Pa	1350 Pa	1500 Pa
km/h	0	32	45	55	64	72	78	96	111	126	138	149	159	169	178
Classe	-	1A	2A	3A	4A	5A	6A	7A	8A	E750	E900	E1050	E1200	E1350	E1500

8A

Perméabilité à l'air* EN 1026 - EN 12207

Classe
Obtenu



Pression vent	150 Pa	300 Pa	450 Pa	600 Pa
Classe	1	2	3	4

3

Resistance à la charge du vent* EN 12211 - EN 12210

Classe
Obtenu



Pression air	400 Pa	800 Pa	1200 Pa	1600 Pa	2000 Pa	>2000 Pa
Flessione	A("1/150)		B("1/200)		C("1/300)	
Classe	1	2	3	4	5	Exxx

B3

* Fenêtre à 2 vantaux, dimensions LxH 1790X2190 mm

Rapport d'Essai n° 1994-CPR-RP3005 du 22 Avril 2025

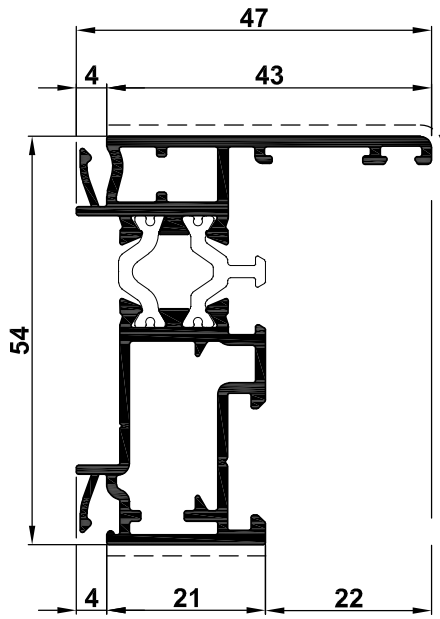

BT.0105
1,059 kg/m

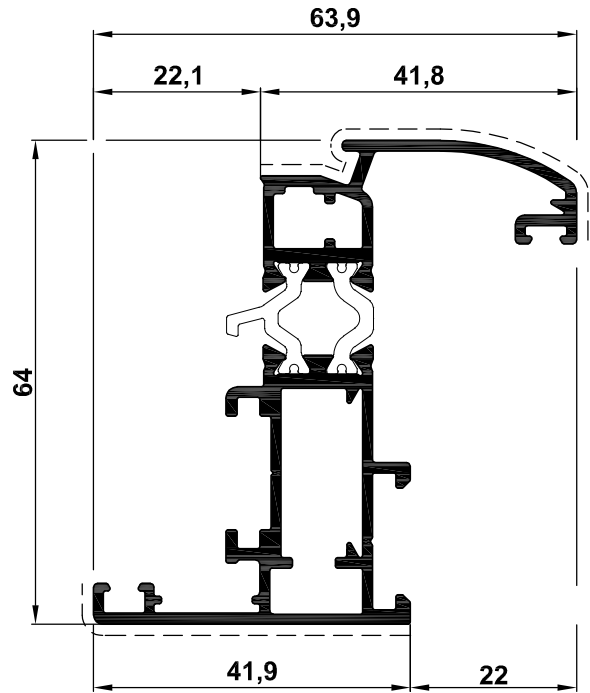

BT.0204
1,272 kg/m

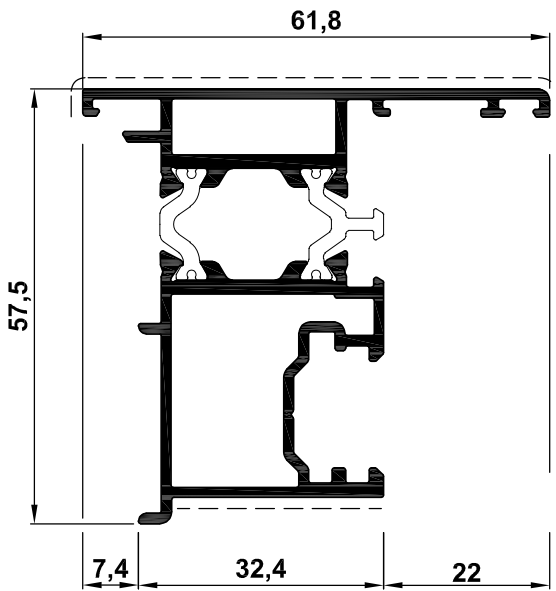

BT.0200
1,268 kg/m

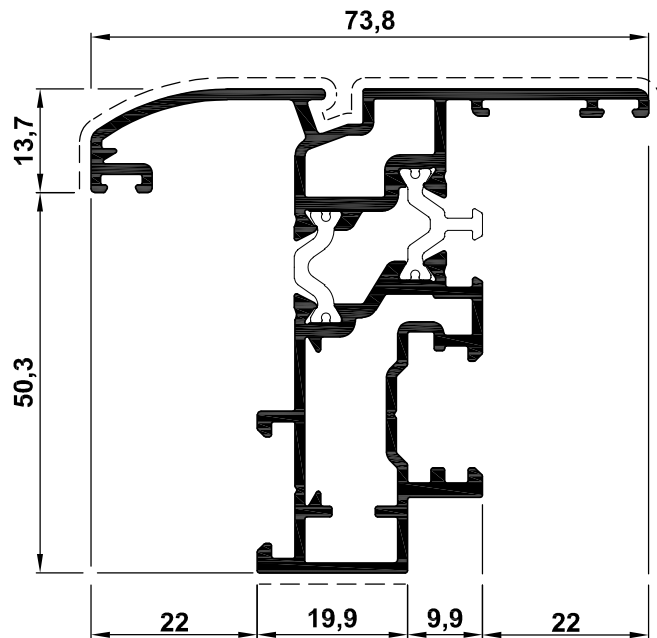

BT.0208
1,268 kg/m

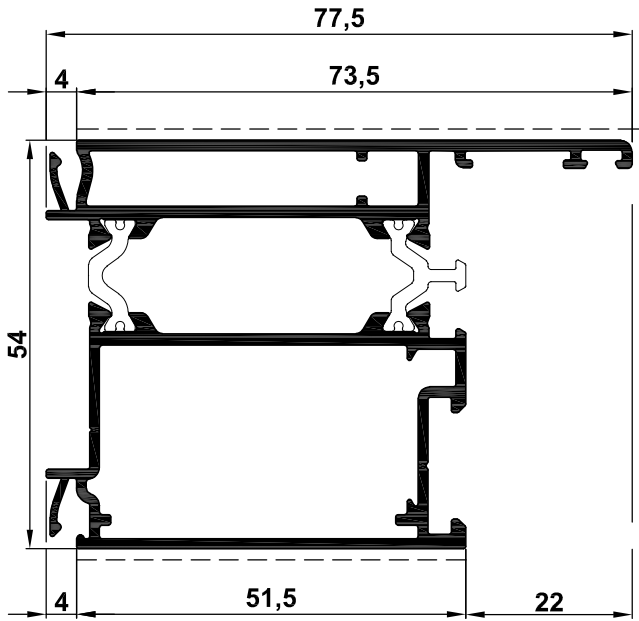

BT.0125
1,558 kg/m

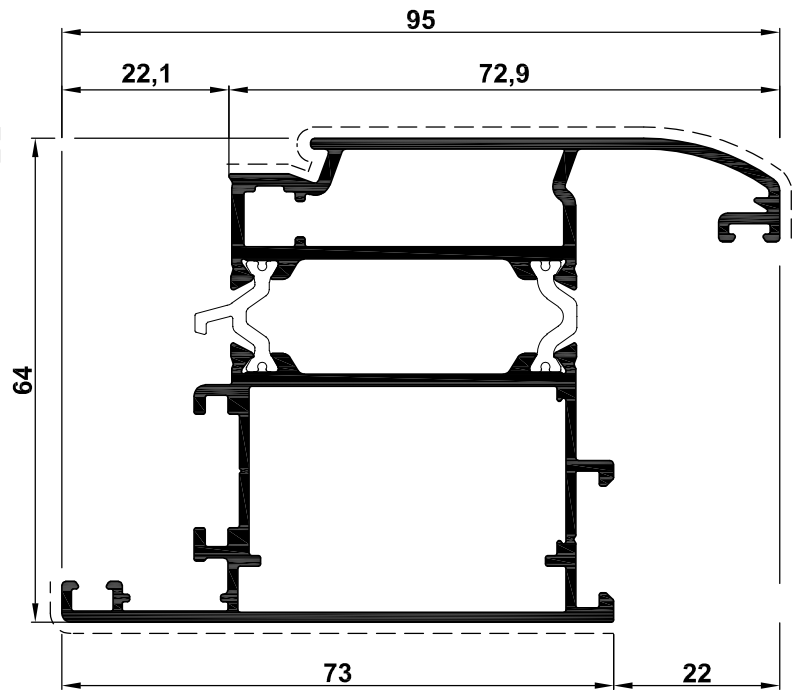

BT.0224
1,834 kg/m

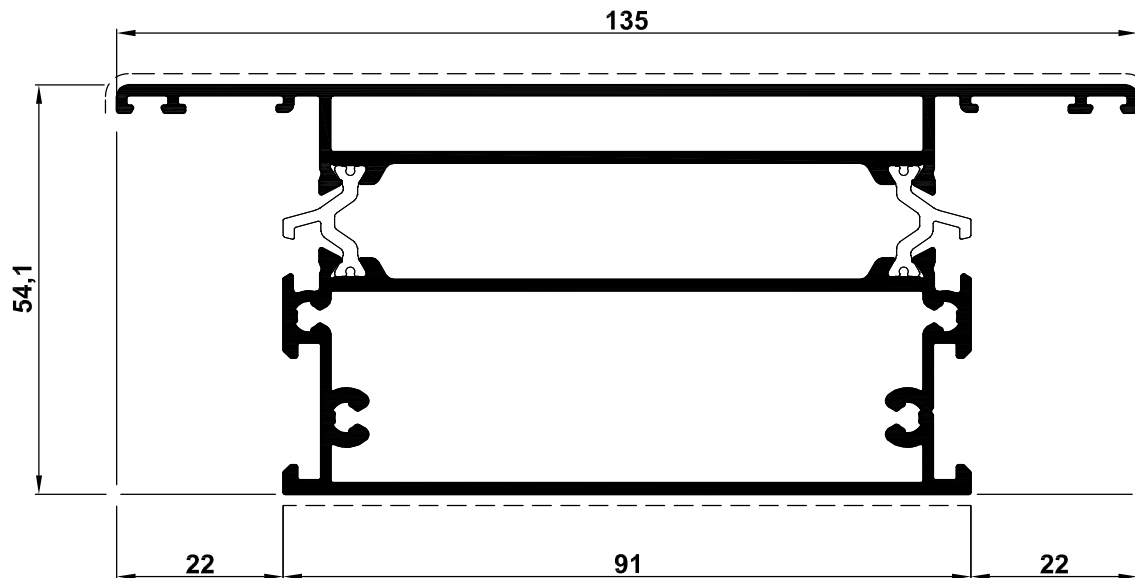

BT.0330
2,411 kg/m

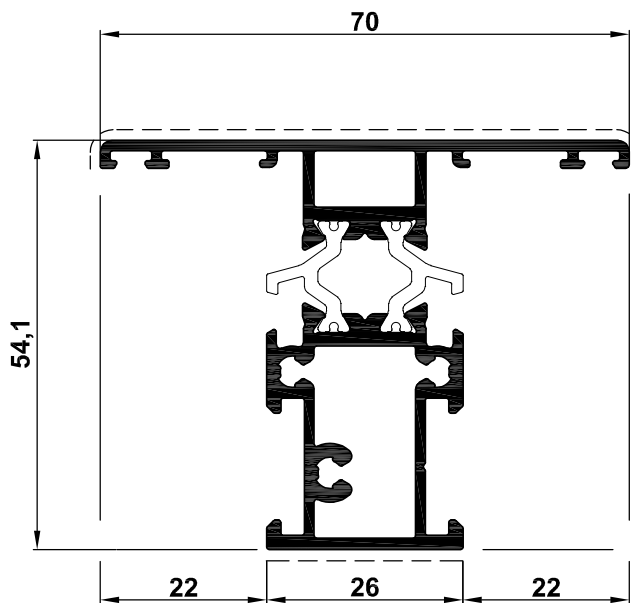

BT.0305
1,314 kg/m

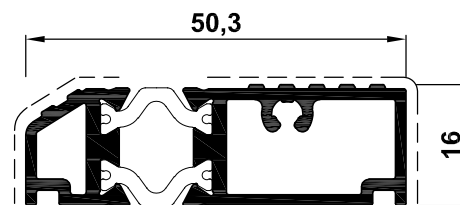

BT.0332
0,790 kg/m

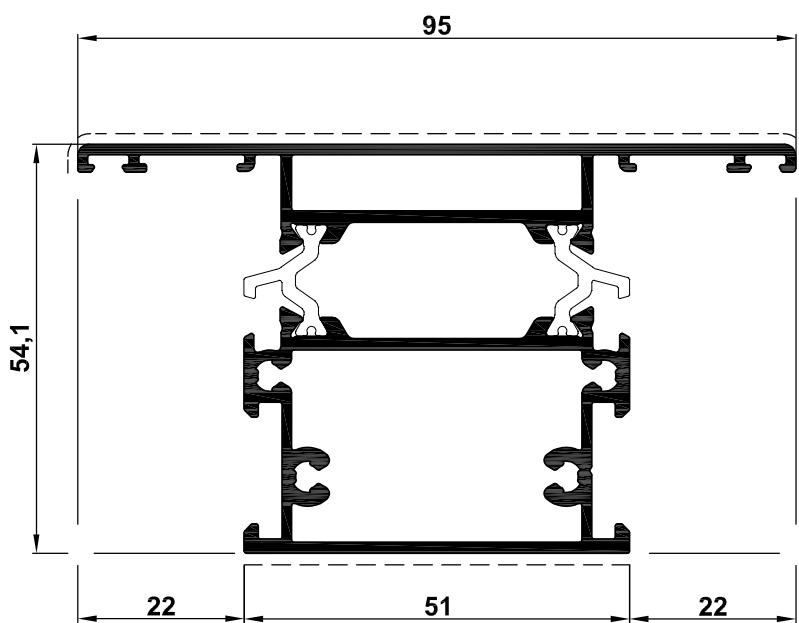

BT.0325
1,774 kg/m

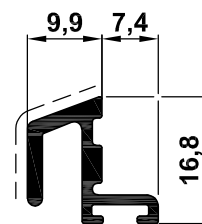

B.0050
0,232 kg/m

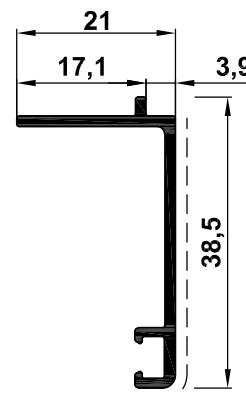

B.0060
0,251 kg/m

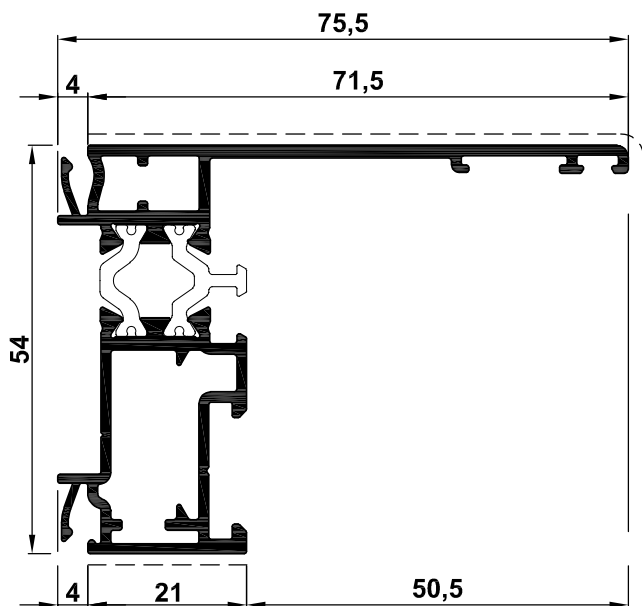

BT.0333
1,191 kg/m

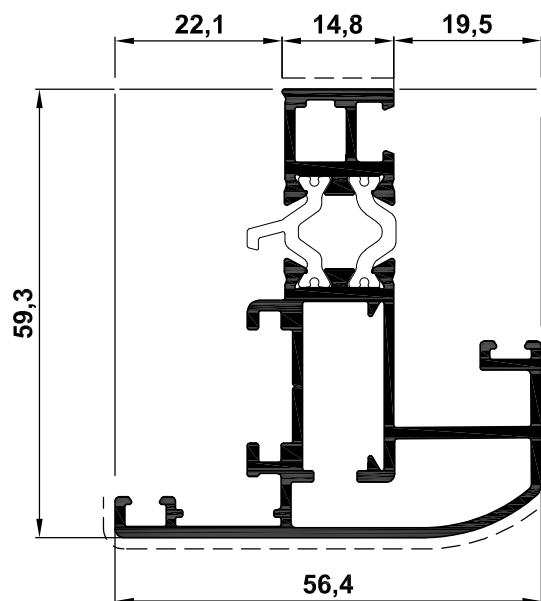

BT.0334
1,242 kg/m

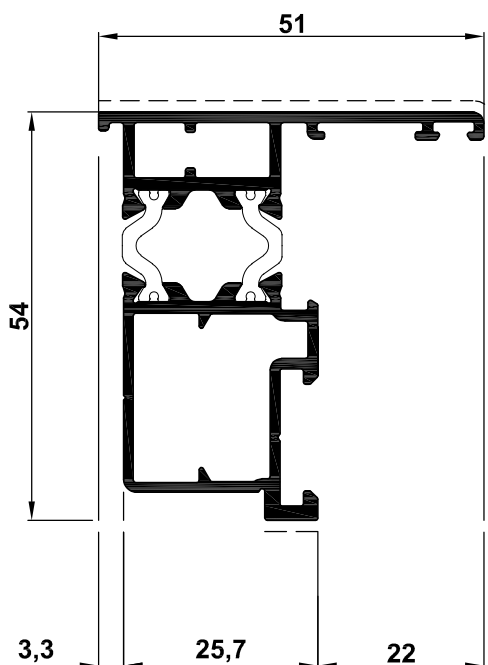

BT.0227
1,057 kg/m

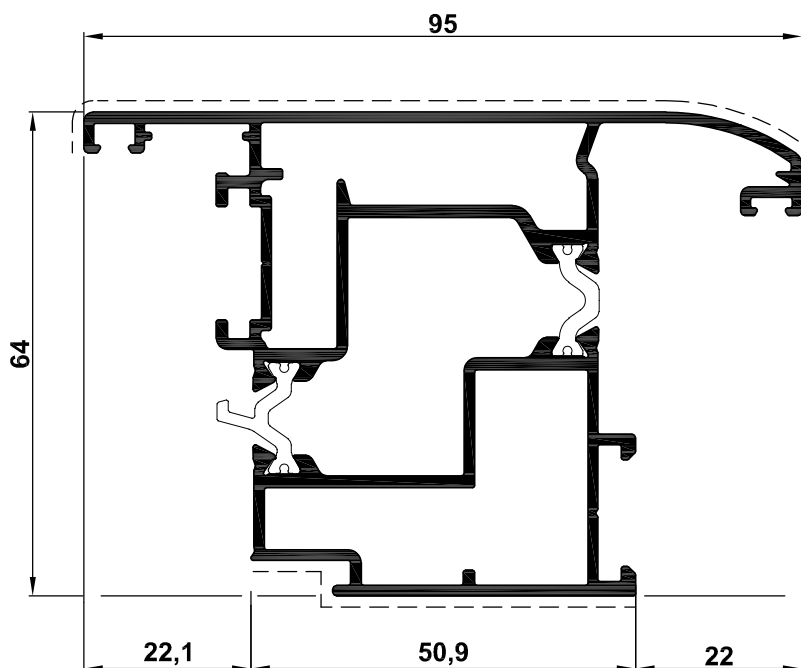

BT.0226
1,929 kg/m

PROFILES

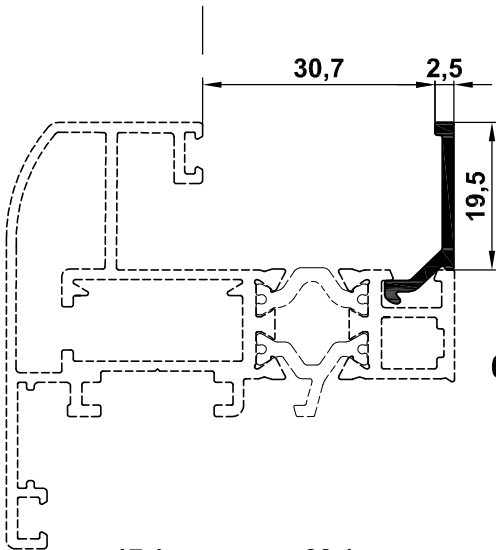

B.0743
0,126 kg/m

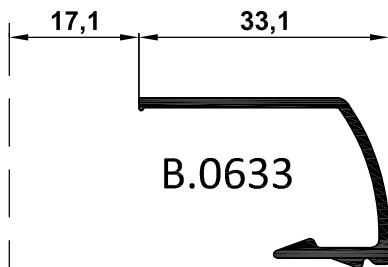

B.0633

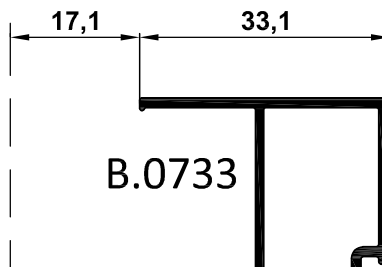

B.0733

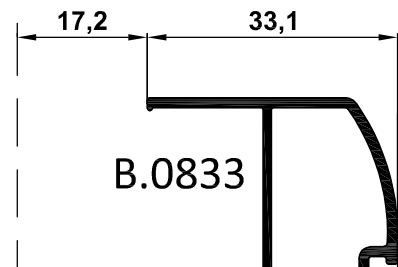

B.0833

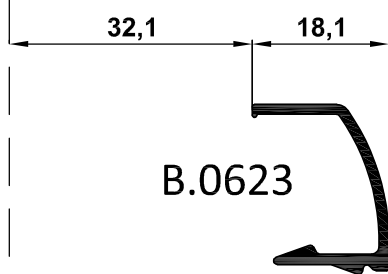

B.0623

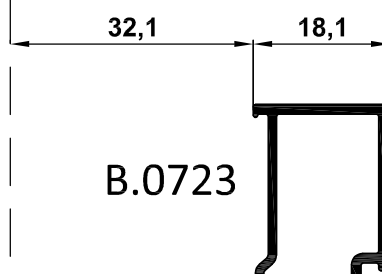

B.0723

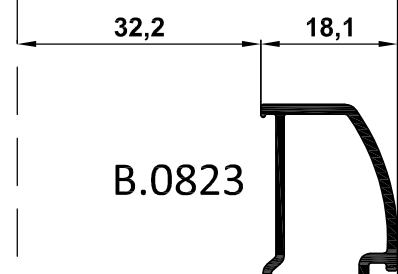

B.0823

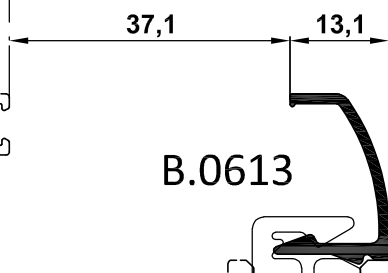

B.0613

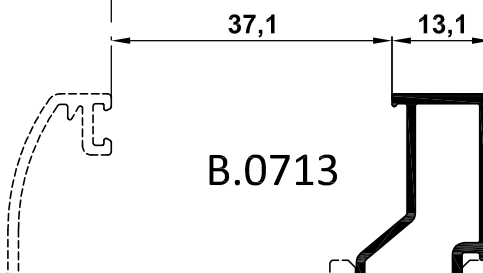

B.0713

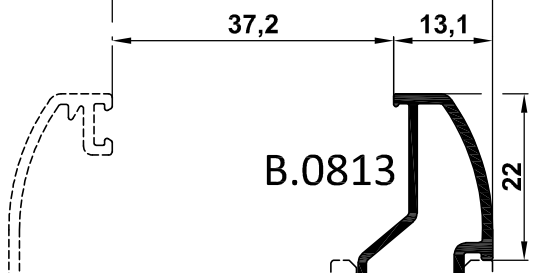

B.0813

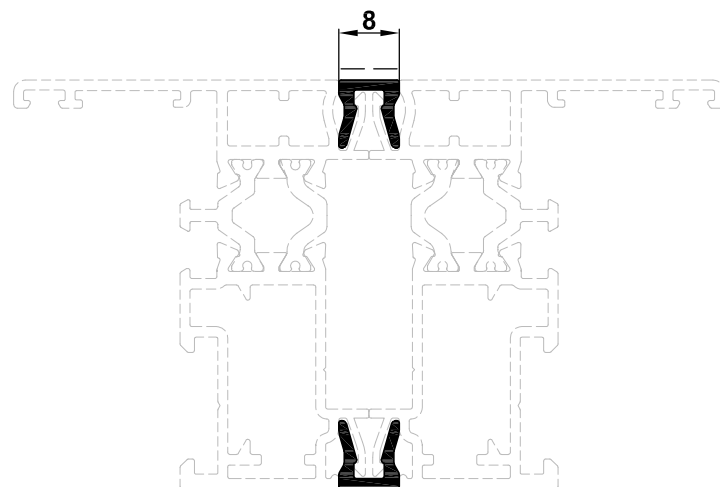
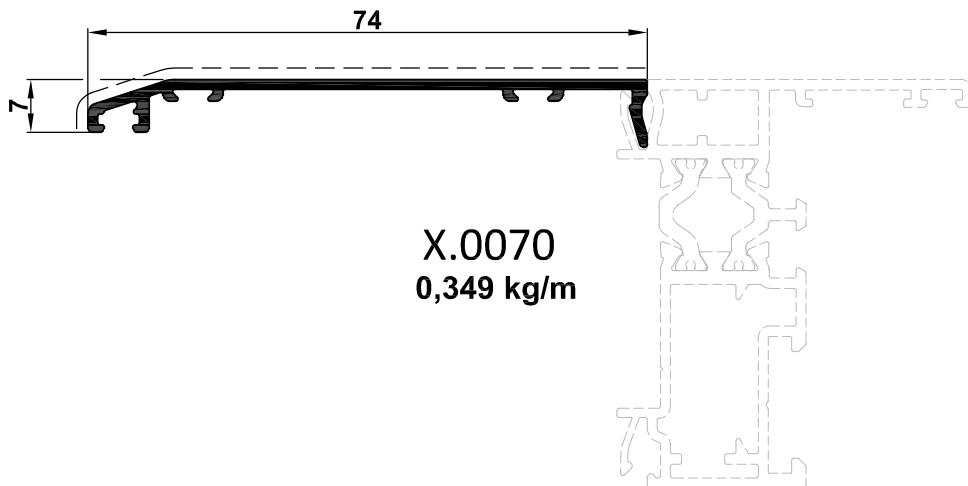
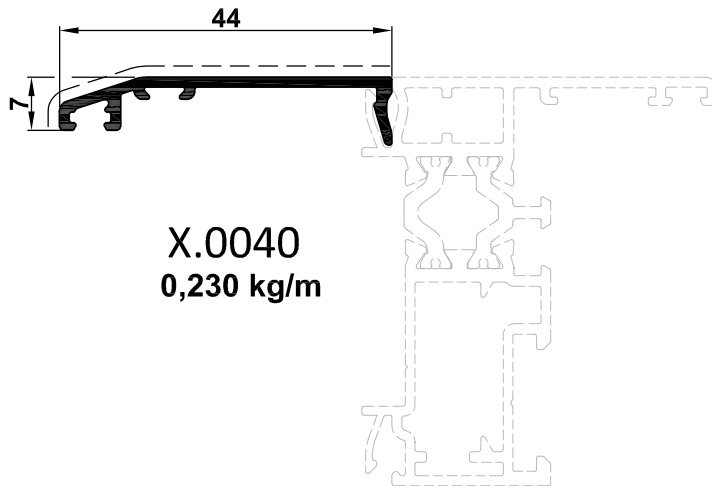

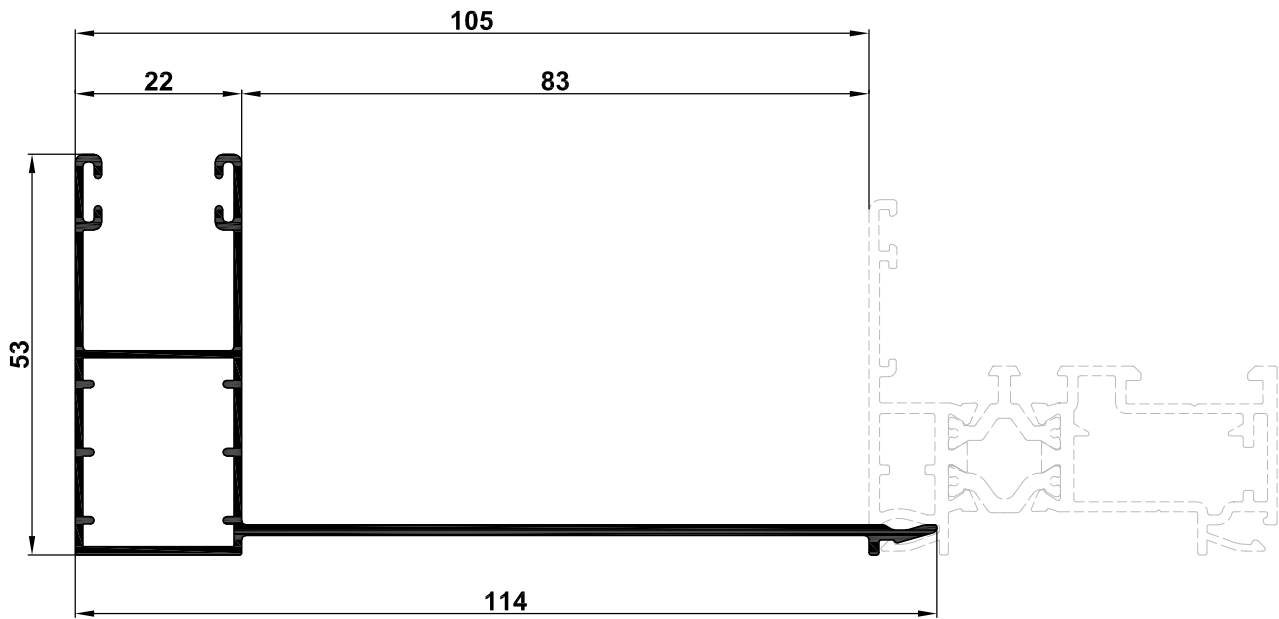

X.3105
0,823 kg/m

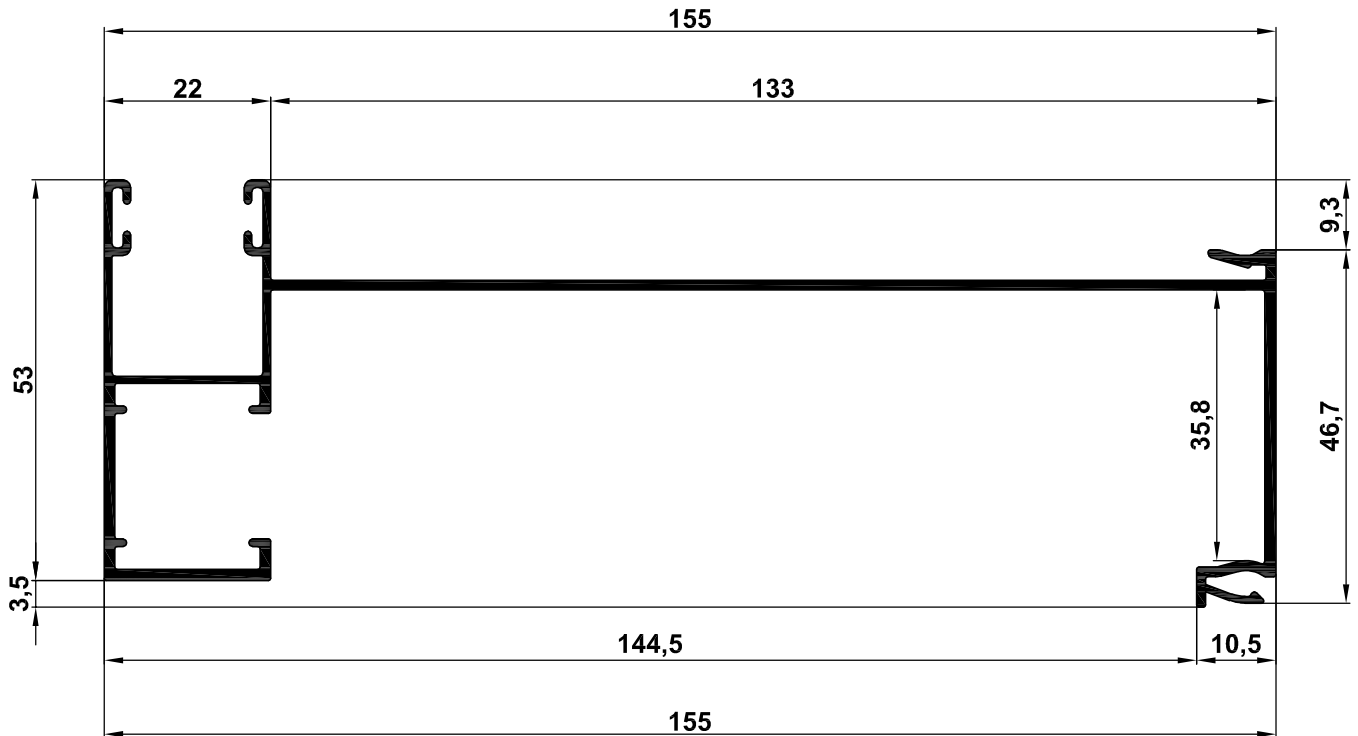

XP1.155
1,201 kg/m

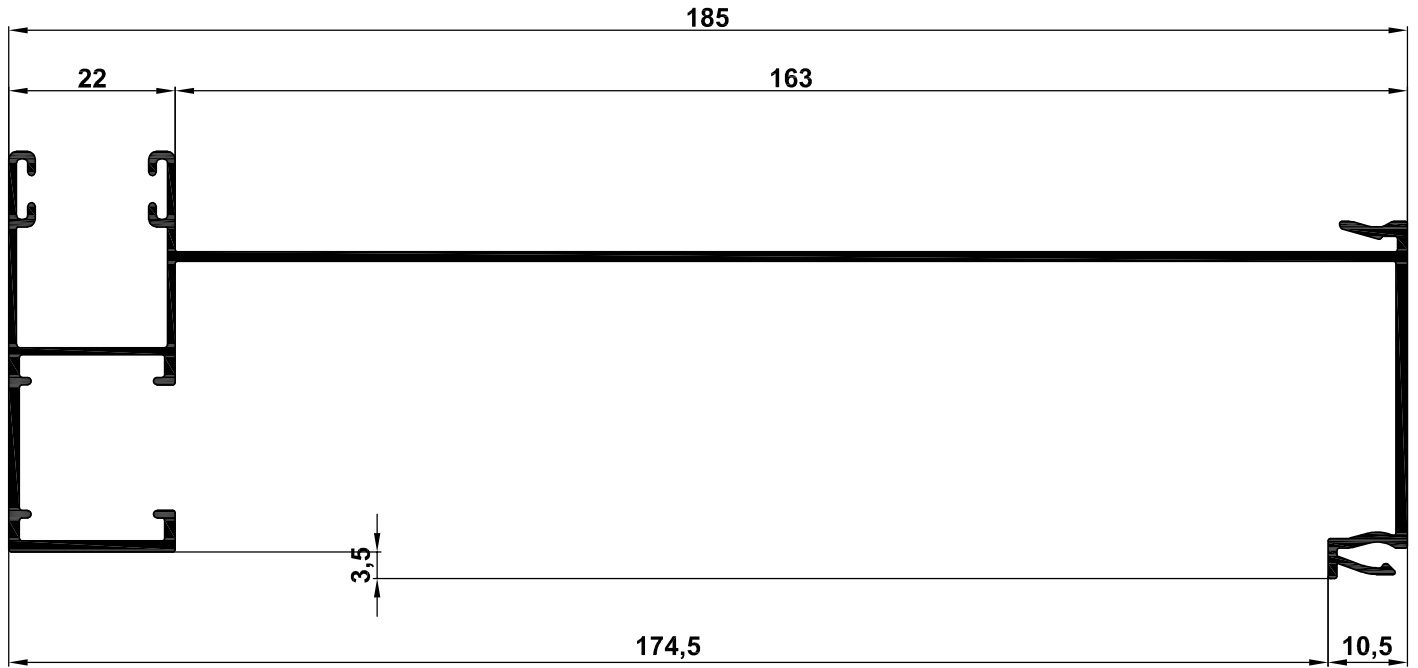



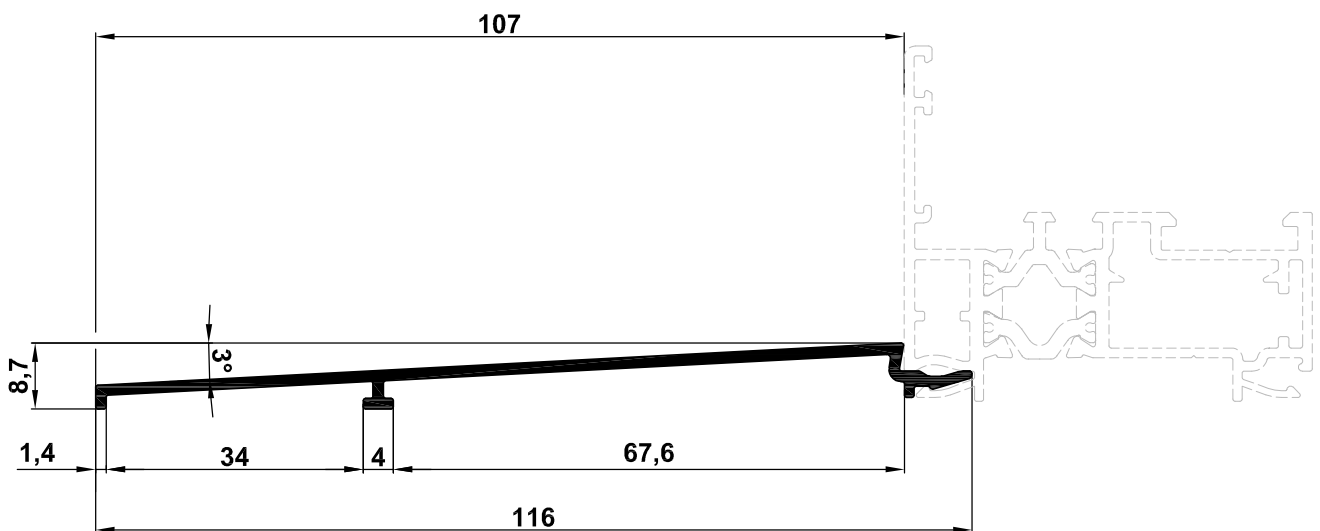





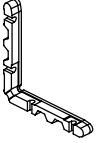
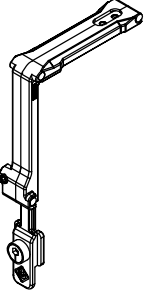

XP2.185
1,307 kg/m

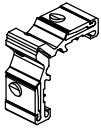
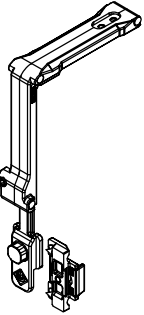
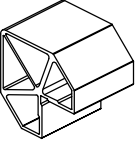
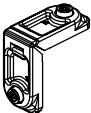

X.2105
0,492 kg/m

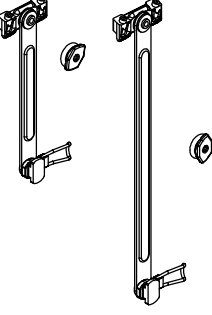
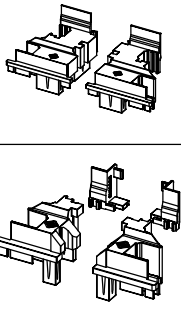
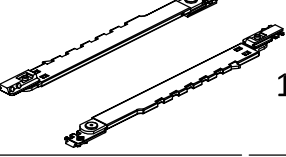



NOMENCLATURE ACCESSORIES





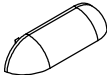

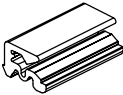
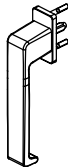
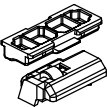
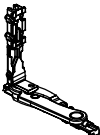

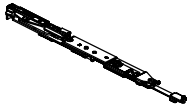
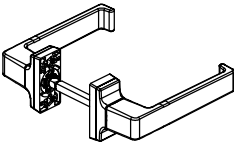
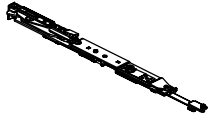
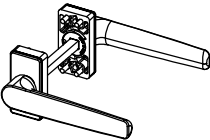
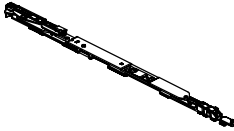
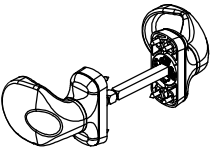
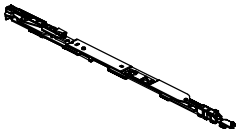
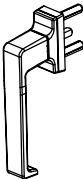
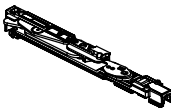
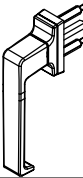
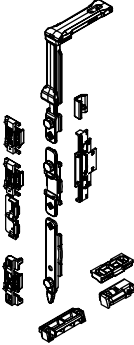
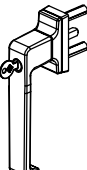
REF.	DESCRIPTION	REF.	DESCRIPTION
	0141 Equerre d' alignement		1252.100 Renvoi d'angle
	0140 Goupil pour Équerre pour goupillage et sertissage		
	0265.50 Equerre		1252.111 Renvoi d'angle avec point de fermeture supplémentaire
	028X Supplément Equerre 21.9x31.7 mm		
	0358 Equerre		
	PP2188.5 Equerre d' alignement		1500.5 Cliquet en zamak
	2194.1 Equerre d' alignement		2010.2B Tringle
	1115.2 Bras liiteur d'ouverture vantail hauteur 290 à 800 (Charge maximale 70 kg)		PP2081.18 Embout battement central
	1115.1 Bras liiteur d'ouverture vantail hauteur 600 à 1600 (Charge maximale 70 kg)		PP2081.19 Embout battement central réduit
	1210.1 STAR Bras Télescopique à déclic (Charge : 80 kg à charge statique)		2129.4 Cache cylindre Italia
	1233.16 EASY RAPID Charnières amorties		2133 Verin de pose

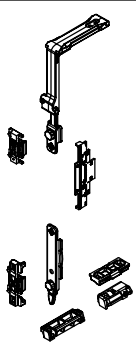
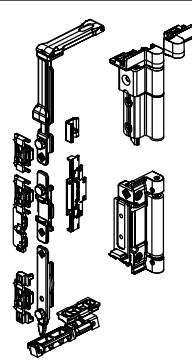
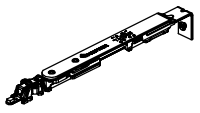
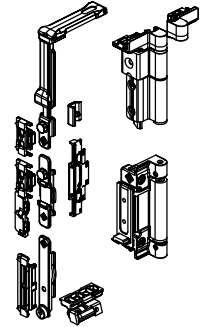
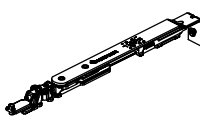
NOMENCLATURE ACCESSORIES

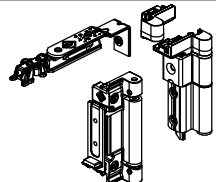
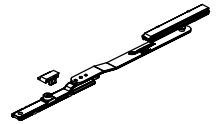
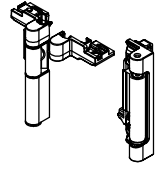
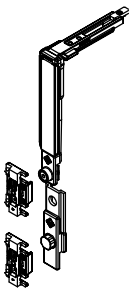
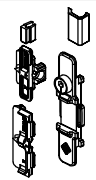



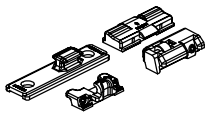
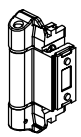







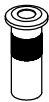



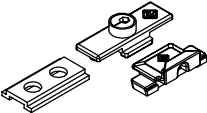

	REF.	DESCRIPTION		REF.	DESCRIPTION
	2145	Busette d'évacuation		3077.25	Poignée pour vantail oscillo-battant manoeuvre logique-à souffle ouverture à droite et gauche.
	2210	Clip parclose		3090.30	Bequille a poignée design minimaliste <i>ITALIA</i>
	2432.1	Point support vantail		3304	Paumelle inf invisible s/d
	3042	Poignée à olive		3304.20	Bras court réglable pour paumelle invisible vantail semi fixe s/d
	3065	Double bequille <i>ITALIA</i>		3304L.20	Bras cort réglable pour paumelle invisible vantail semi fixe s/d manoeuvre Logique
	3068.1	Bequille double baissée <i>KARMA</i>		3304.21	Bras long réglable pour paumelle invisible vantail semi fixe s/d
	3064.1	Poignée Spin		3304L.21	Bras long réglable pour paumelle invisible vantail semi fixe s/d manoeuvre Logique
	3072	Bequille a poignée <i>ITALIA</i>		3304.71	Paumelle invisible s/d
	3072.1	Bequille a poignée <i>ITALIA</i>		3320F.1	Kit de fermeture Ween
	3077.2	Bequille a poignée <i>ITALIA</i>			

REF.	DESCRIPTION	REF.	DESCRIPTION
	3320F.3 Kit de fermeture Ween		3420F.1 Kit base Ween oscillo battent
	3400.20 Bras ob Ween (vantail 370-450)		3420LF.1 Kit ob Ween - Manoeuvre Logique
	3400.21 Bras ob Ween (vantail 451-650)		
	3400.22 Bras ob Ween (vantail 651-1700)		3420.23 Kit paumelle ob Ween vantail semi fixe
	3520.30 Bras supplementaire ob Ween (vantail 1200-1700)		3420.24 Kit paumelle ob Ween
	3420F.31 Point fermeture supplémentaire		6011.13 Bloc de jonction p/ oscillo battent
			3630.20 Mouvement mono directionnel Entrée 3,3 mm. Avec dispositif anti fausse manoeuvre.
	3400F.32 Point fermeture supplémentaire		3627.2 Mouvement mono directionnel Entrée 11,5 mm. Avec dispositif anti fausse manoeuvre.
	3400.35 Fermeture horizontale Ween		3420.71 Paumelle à peigne

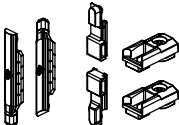

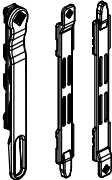







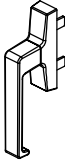

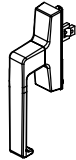

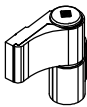

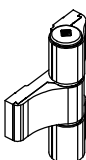
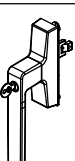
NOMENCLATURE ACCESSORIES

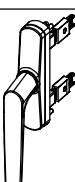

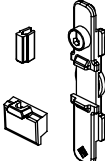

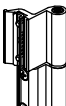
	REF.	DESCRIPTION		REF.	DESCRIPTION
	3626.2	Mécanisme manoeuvre bidirectionnel Entrée 23-35 mm.		4202.1	Gâche
	3630.30	Mécanisme manoeuvre bidirectionnel Entrée 3.3 mm.		4234	Gâche à puits (Diamètre 8 mm)
	3627.20	Inverseur de course bidirectionnel		4207.4	Pivot fermeture supplémentaire
	4011.20	Verrou semi fixe fenêtre		4207.21	Point de fermeture supplémentaire
				4226.1	Crochet fermeture supplémentaire
	4011B.20	Verrou semi fixe fenêtre (Pivot droit ø 8 mm)		4501.50	Verrou a levier
				4504.50	Verrou a levier
	4032.20	Embout de tringle		4032.63	Kit cremone 1 vantail
	4032B.20	Embout de tringle (Pivot droit ø 8 mm)		4515.1	Verrou a levier bi-directionnel
	4206	Double gache cremone		4550.1	Verrou a levier

NOMENCLATURE ACCESSORIES



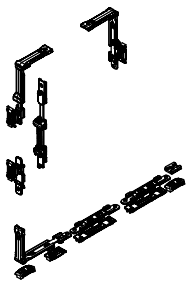

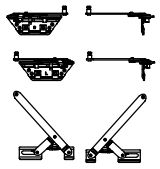
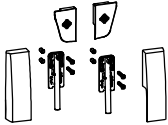
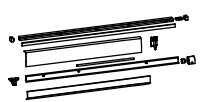
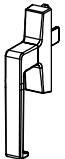
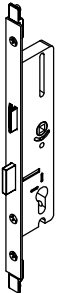



	REF.	DESCRIPTION		REF.	DESCRIPTION
	6008	Crémone <i>ITALIA</i>		8010.14	Fixation pour les profilés à rupture thermique
	6018	Crémone <i>ITALIA</i> p/ oscillo battent		8010.27	Etapas de Dinamika
	6037	Crémone avec clef <i>ITALIA</i>		8011	Paumelles Dinamika deux corps
	6038	Crémone <i>ITALIA</i> p/ oscillo battent avec clef		8011.11	Paumelles Dinamika trois corps
	6038.20	Crémone avec clef <i>ITALIA</i> Manouvre Logique		8060	Paumelle Slim Rapid à deux corps
	6065.3	Crémone ouverture externe (Avec curseurs réglables 37 -60 mm)		8060.6	Paumelle Slim Rapid à trois corps
	6111.1	Bloc de jonction		8060.20	Réglage vert paumelle Silm Rapid
	6401.1	Renvoi de tringle		9211.3	Paumelle Top Rapid à deux corps
	6420E.18	Pivot de jonction (L=18mm)		9211.6	Paumelle Top Rapid à trois corps
	6420E.25	Pivot de jonction (L=25mm)			

REF.	DESCRIPTION	REF.	DESCRIPTION
	3920.2 Kit coulissant parallele semi-automatique		5303.6 Contreplaque réglable pour serrure multipoint
	3900.200D/S Paire chariots pour coulissant parallele droite		
	3915 Kit compas coulissant parallele kit compas universels		
	3910.12 Kit cover pour chariots et compas		
	3940.11 Kit profiles L= 670 - 930 mm 3940.12 Kit profiles L= 931 - 1280 mm 3940.13 Kit profiles L= 1281 - 1680 mm		
	6018.41 Cremone <i>ITALIA</i> pour Coulissant a translation		
	5300.35 Serrure multipoints pour montant bidirectionnel		

NOMENCLATURE ACCESSORIES



REF.	DESCRIPTION	REF.	DESCRIPTION
 IYS 27-10	Joint central	 SY4 - 11	Joint vitrage exterieur 2mm
 SY3-247	Joint de battement	 CF - 4113	Joint vitrage 3mm
 AG1503A	Joint brosse 6,9x8mm avec pinne centrale	 CF - 4114	Joint vitrage 5mm

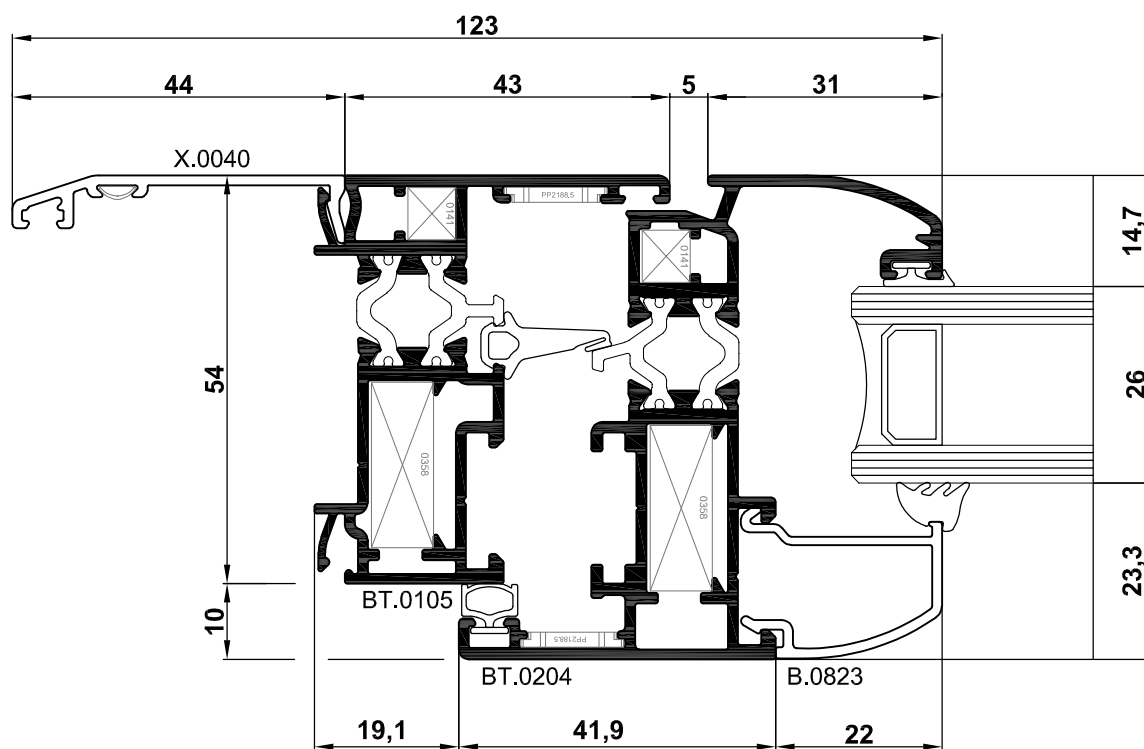
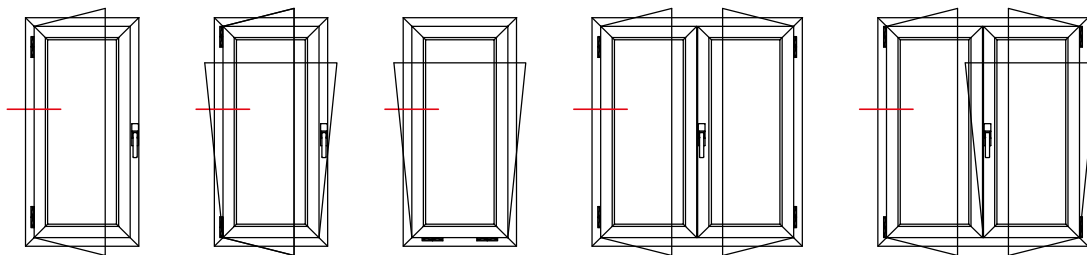

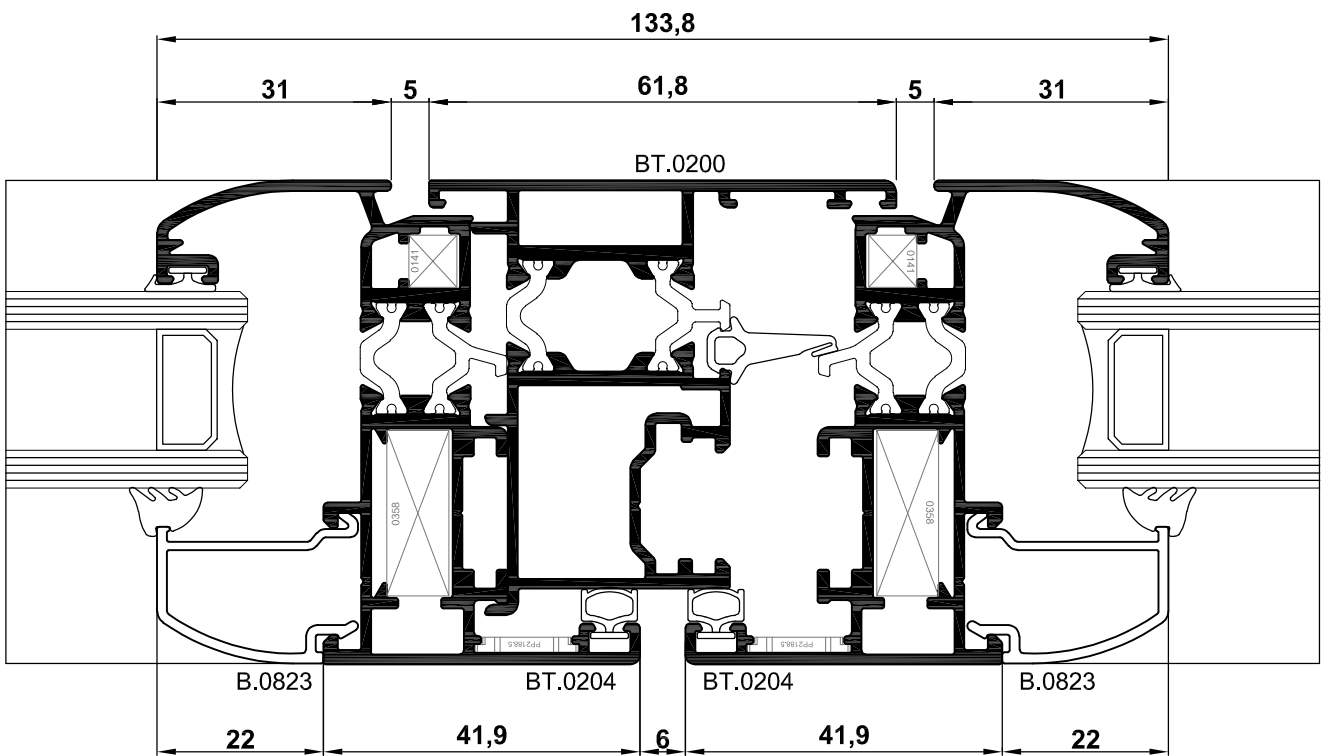
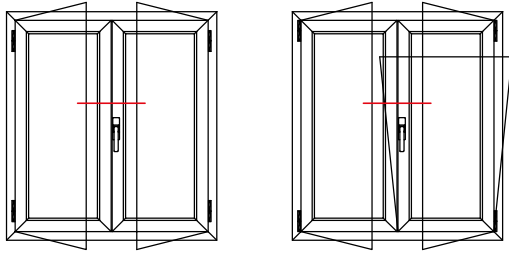

DETAIL

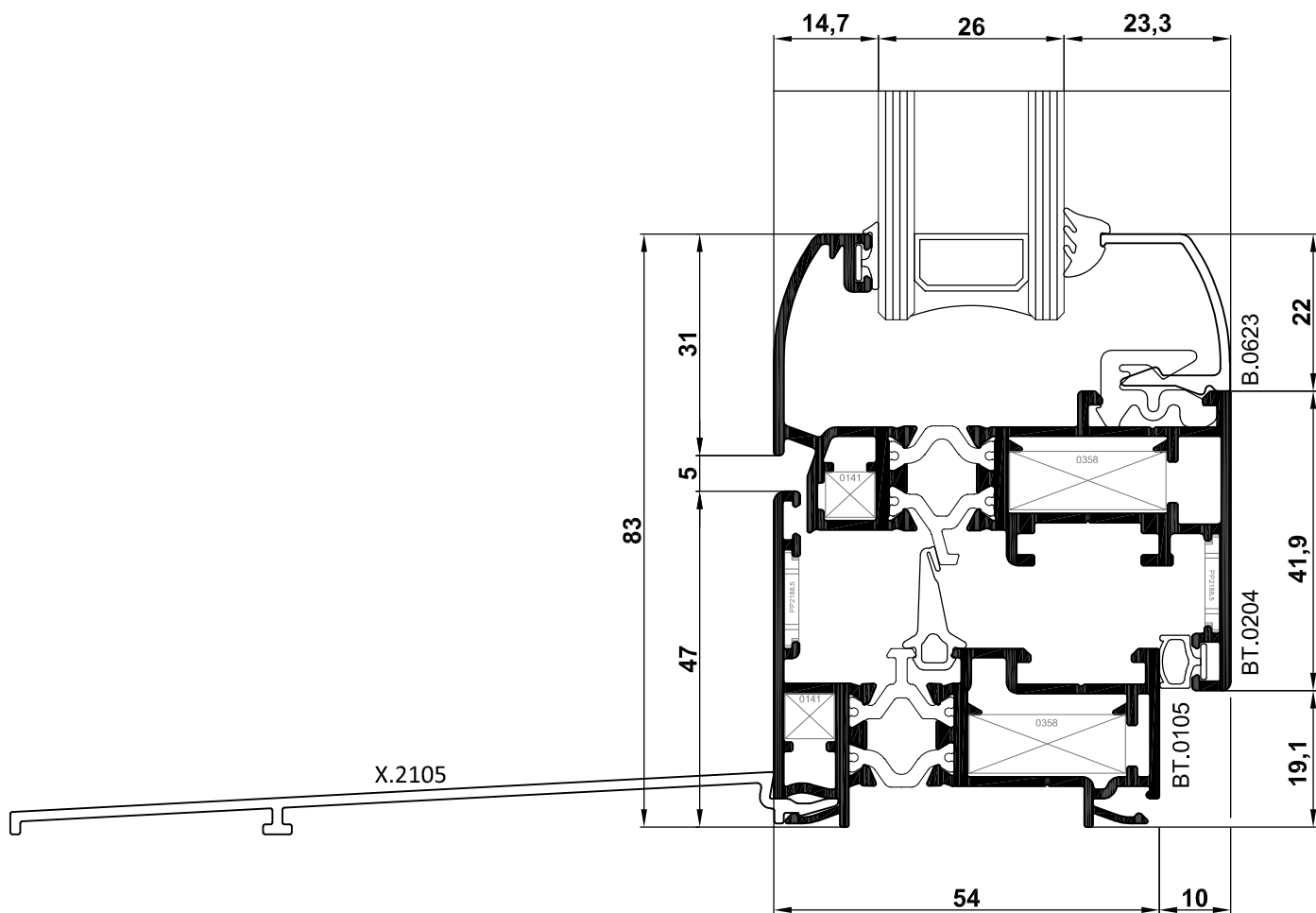
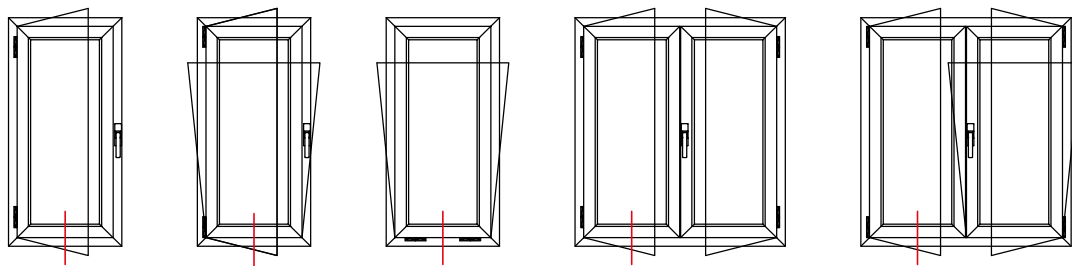

DETAIL

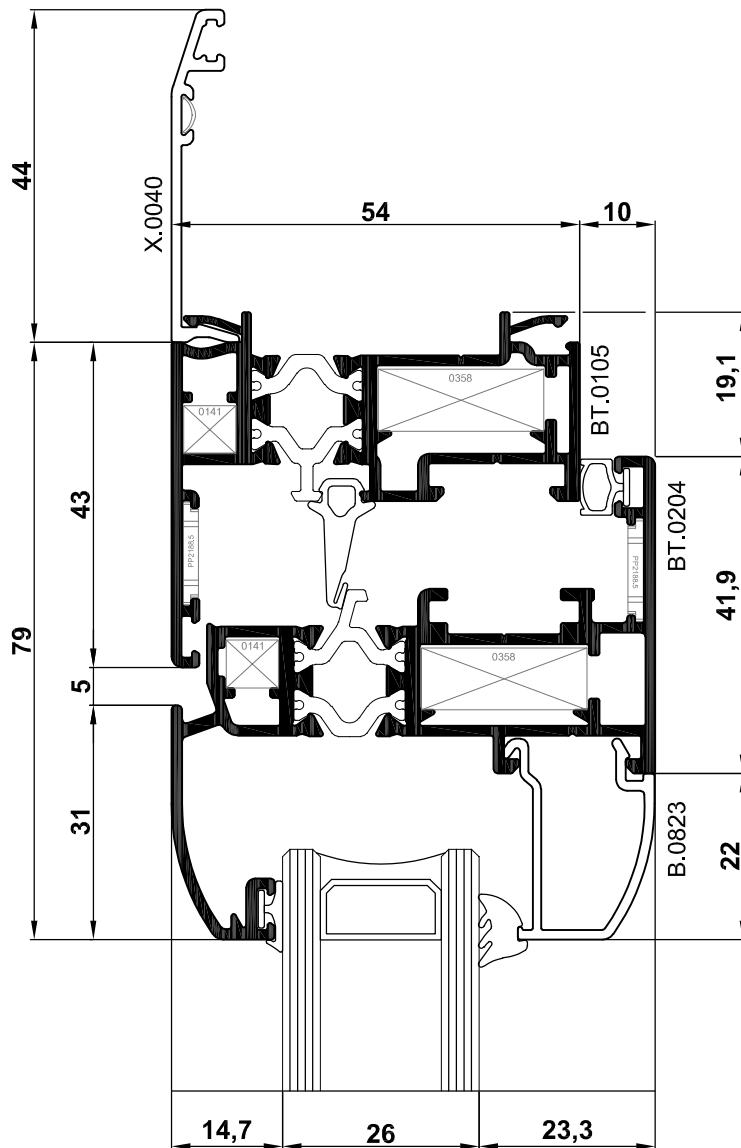
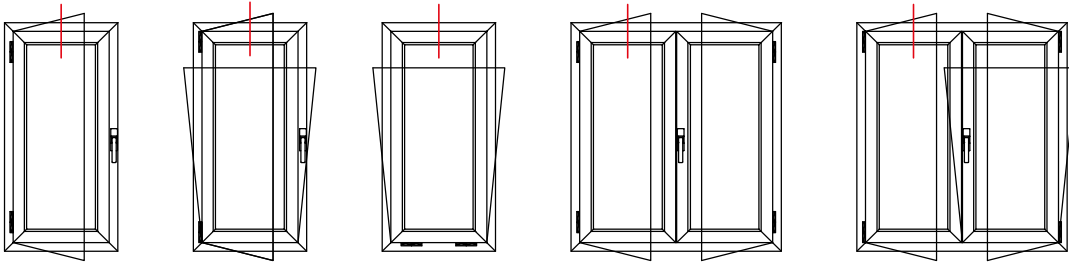

DETAIL

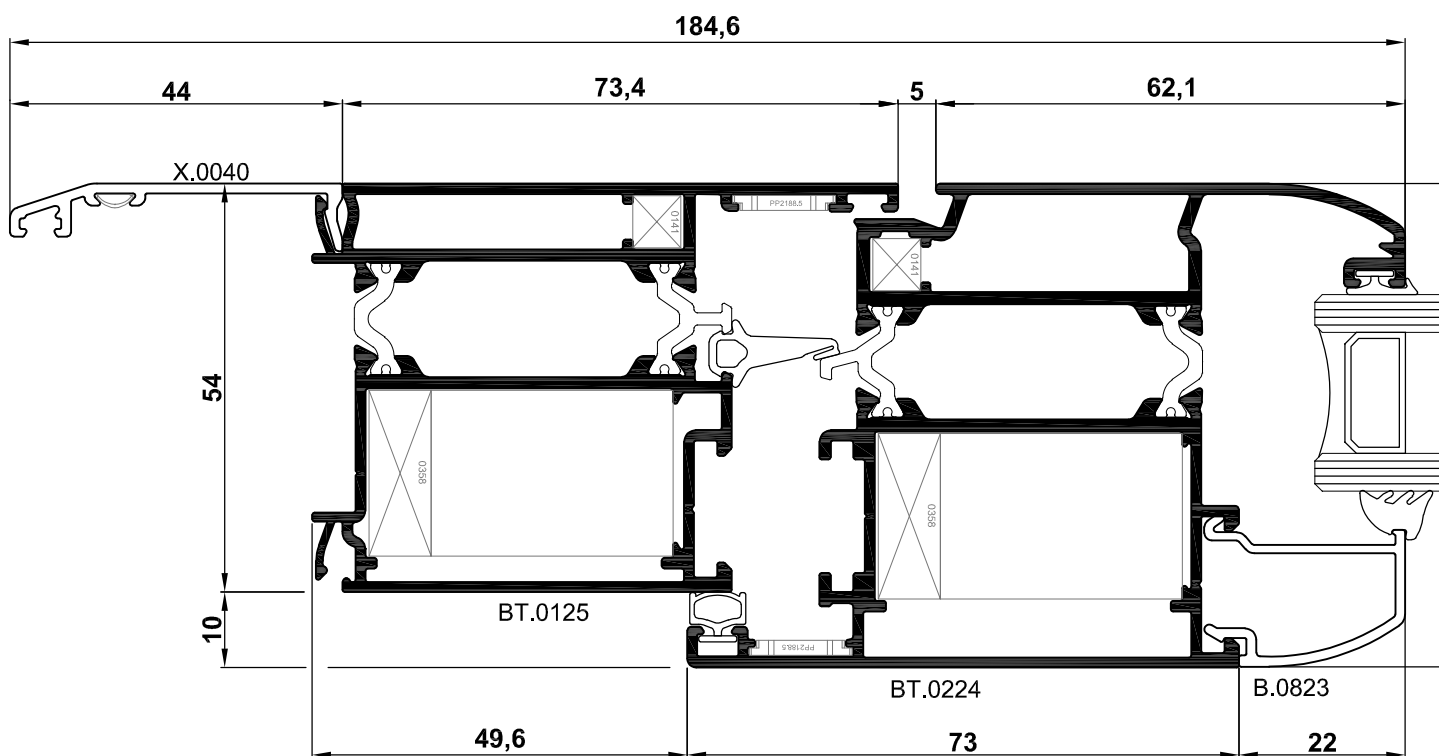
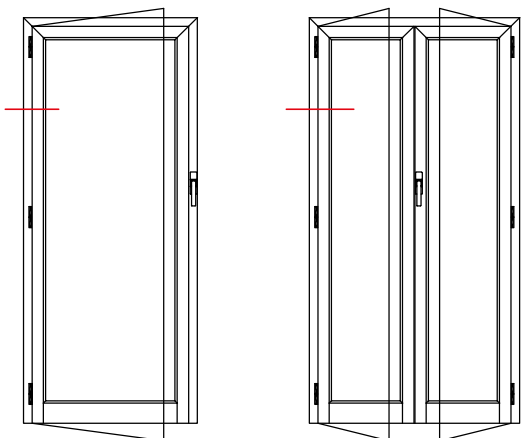

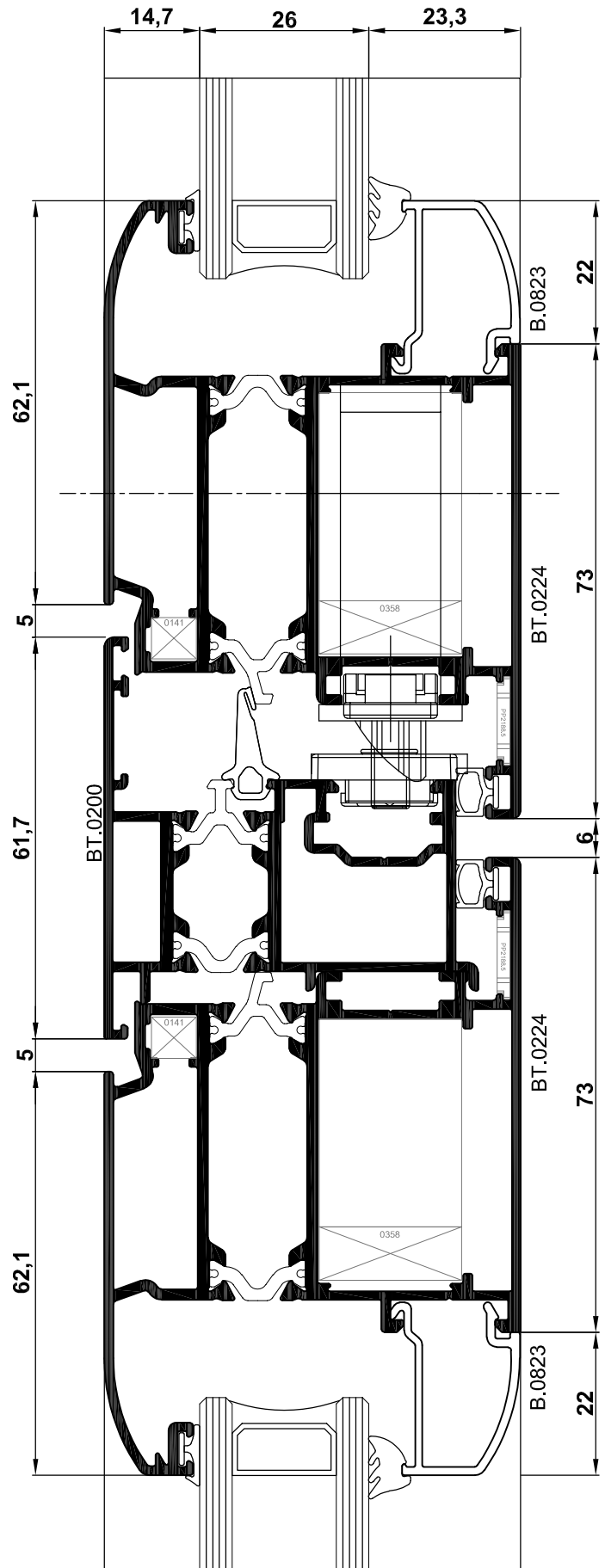
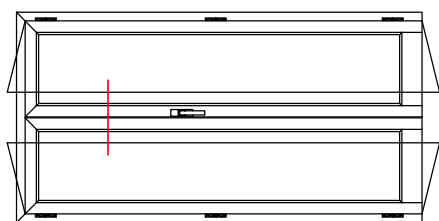

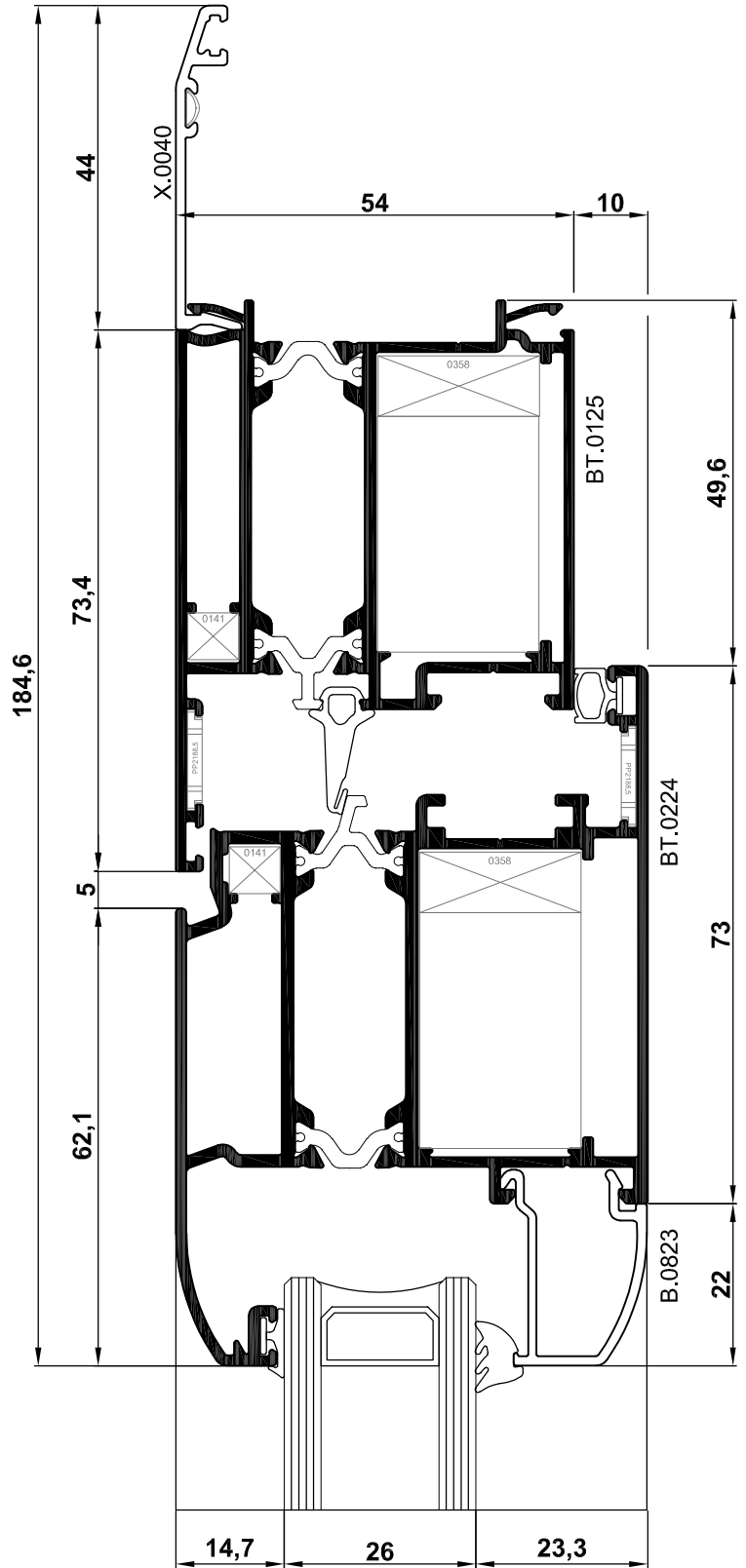
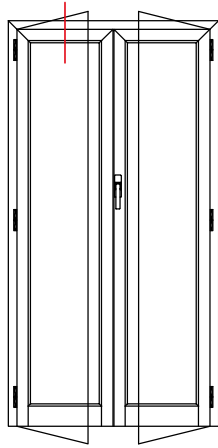
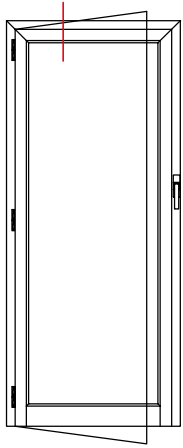

DETAIL

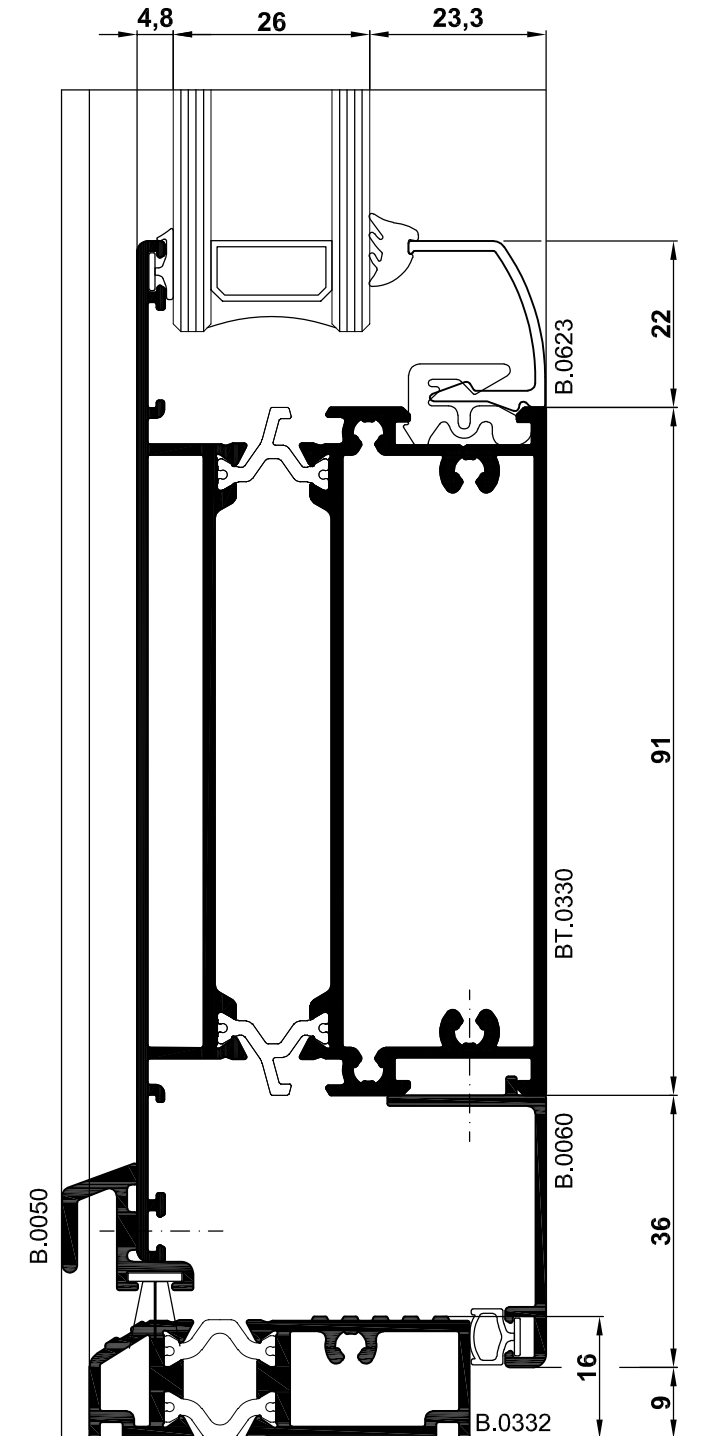
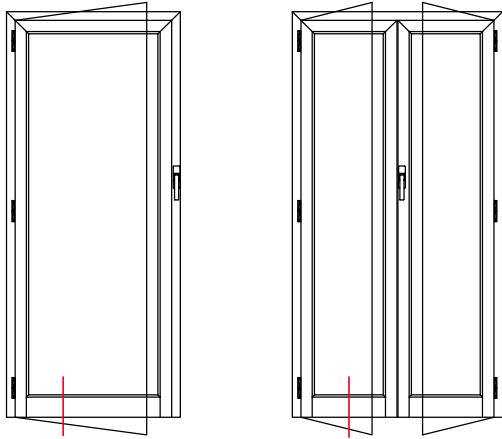

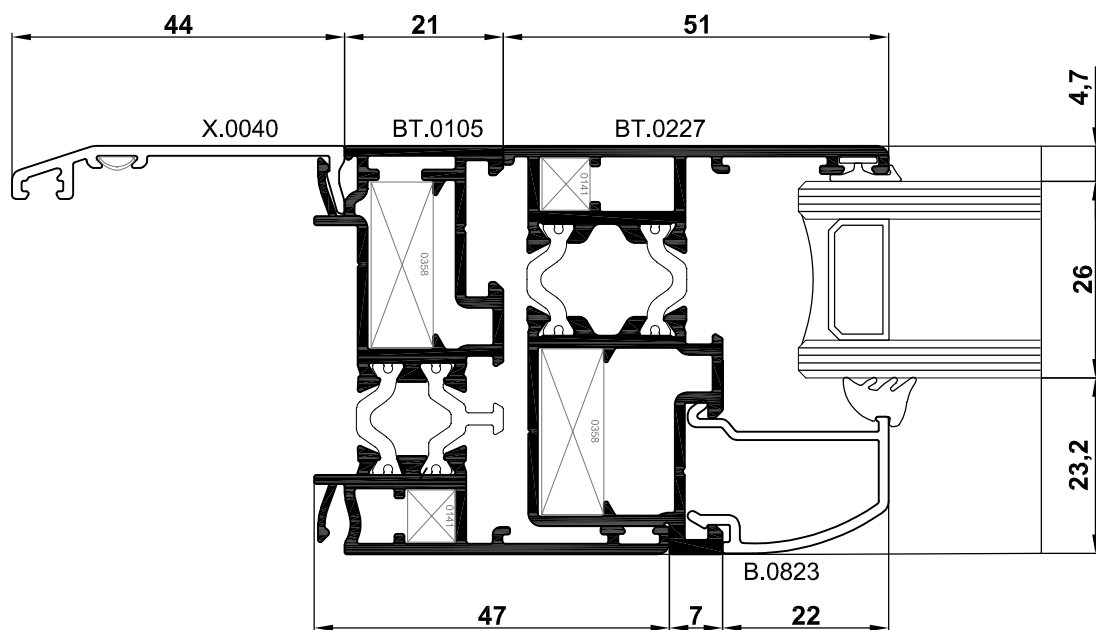
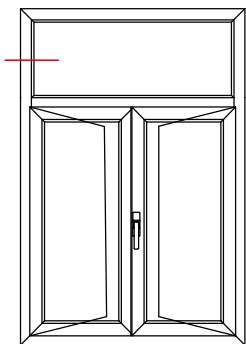

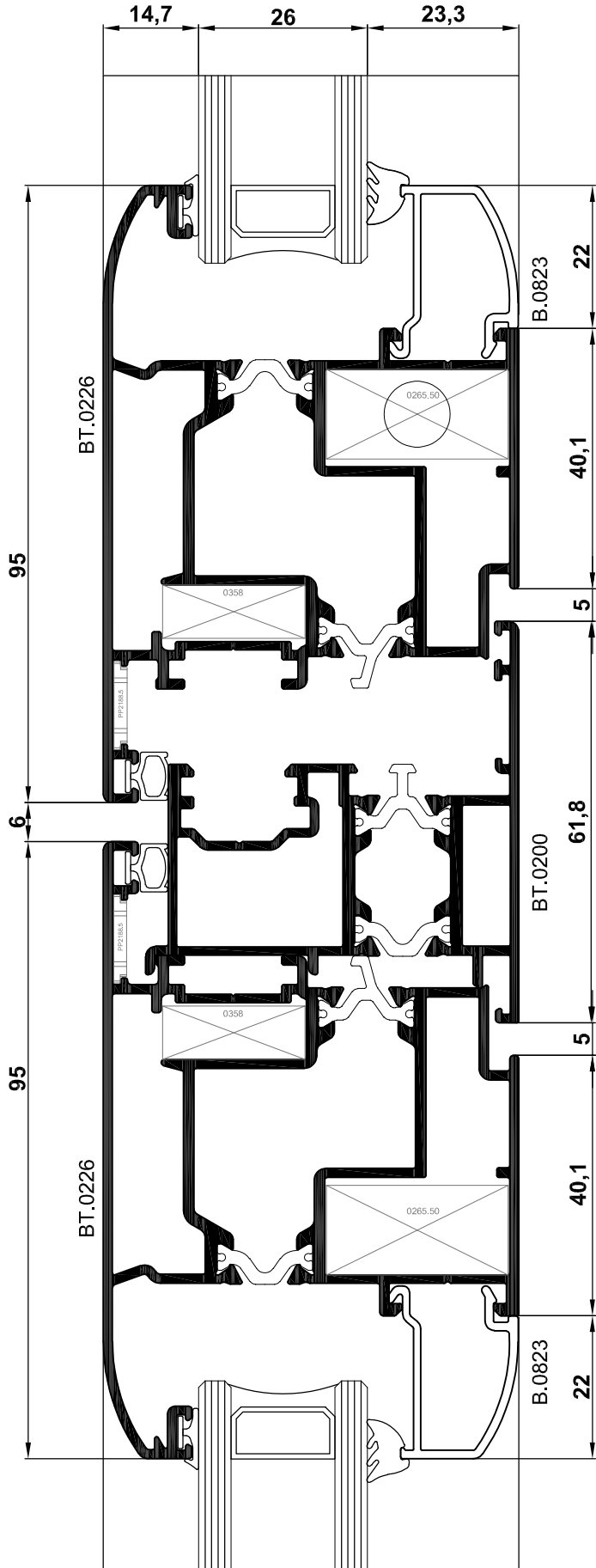
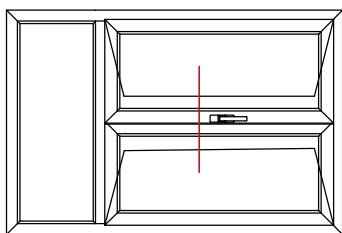

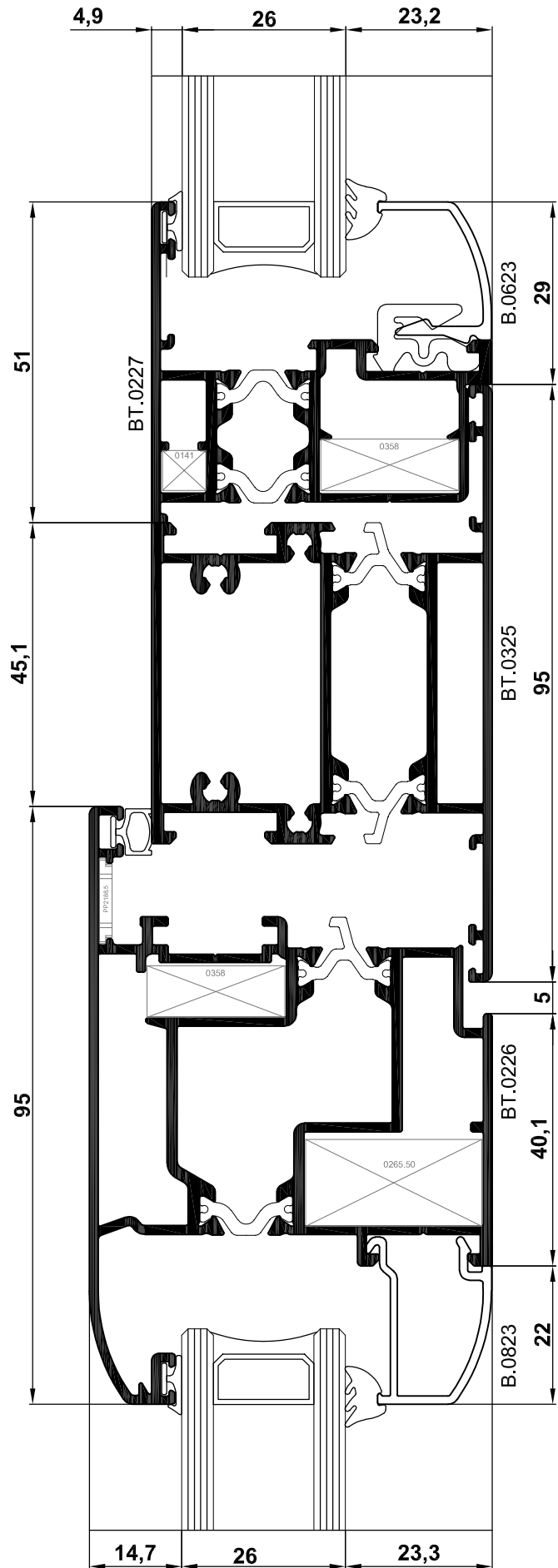
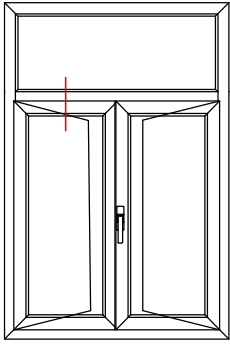

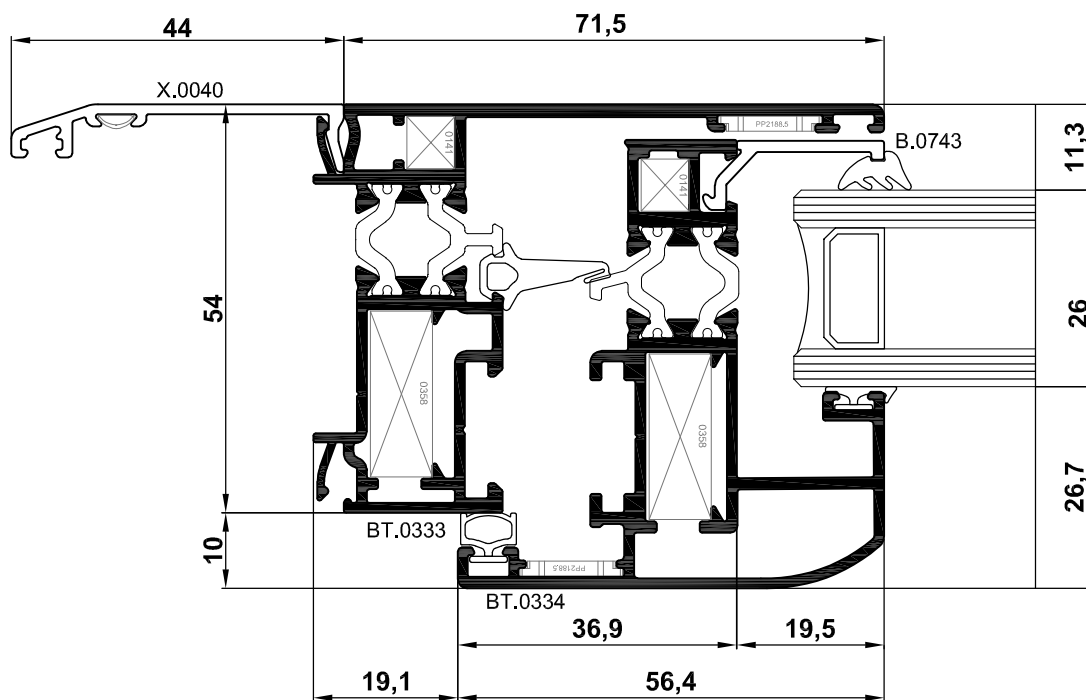
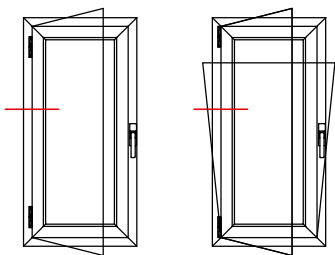

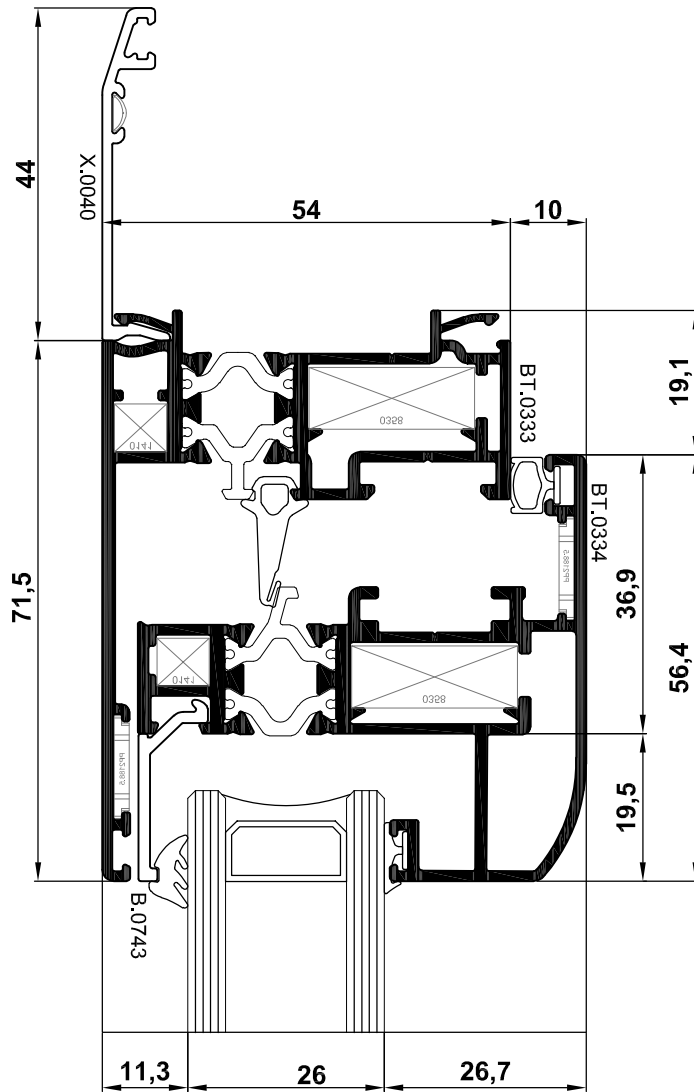
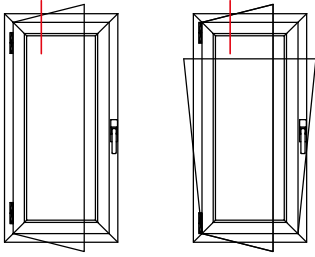

DETAIL

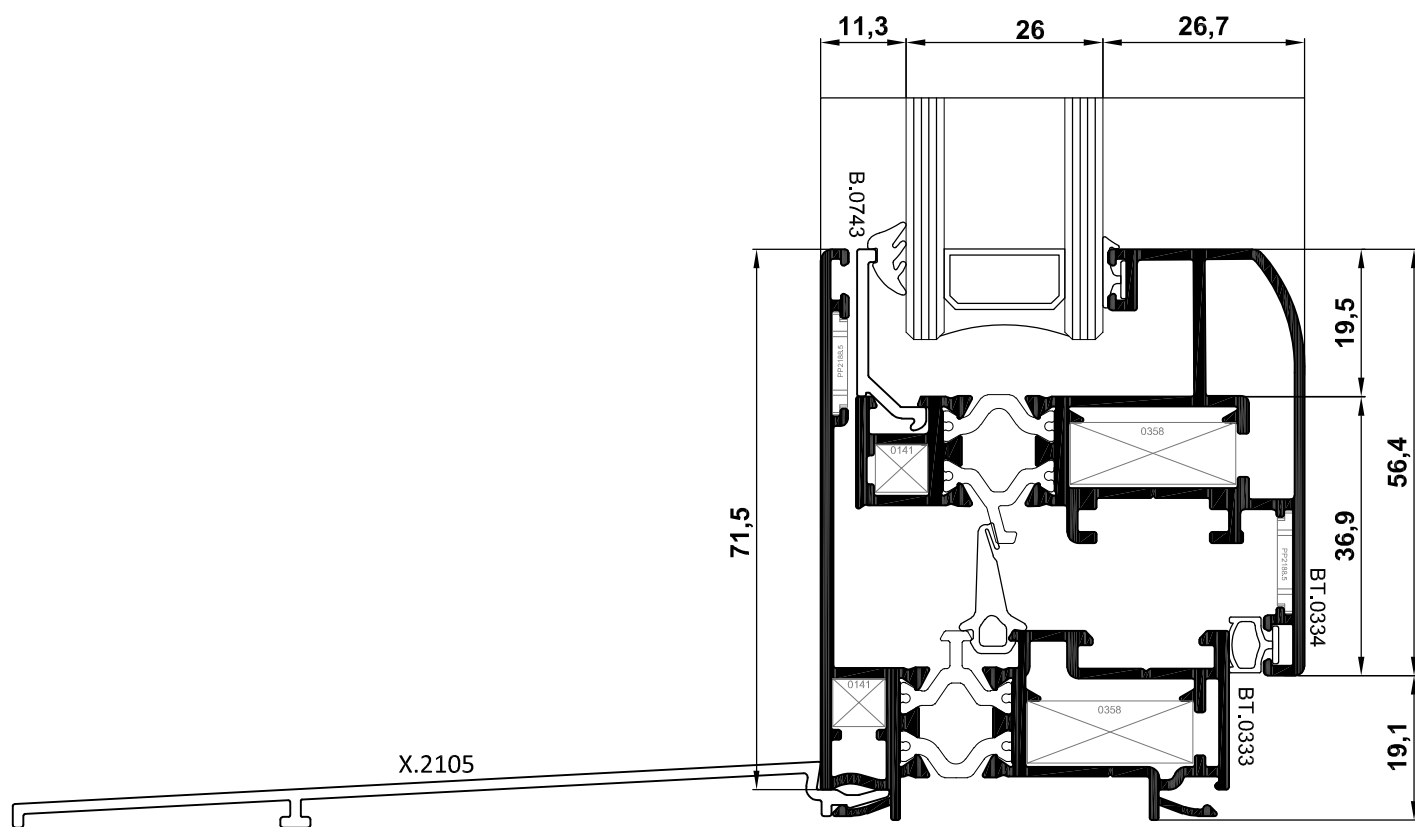
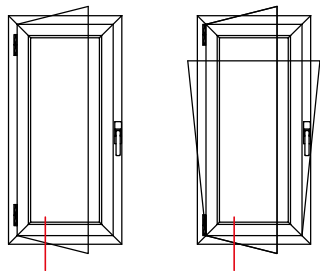

FENETRE BATTANT 1 VANTAIL

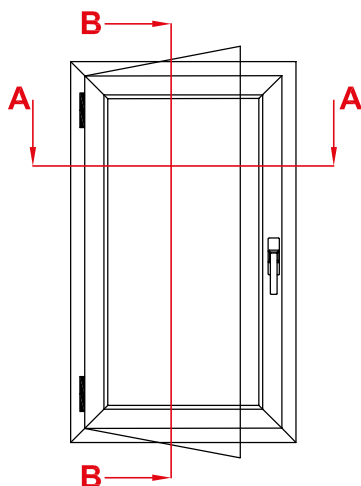

SEC. B-B

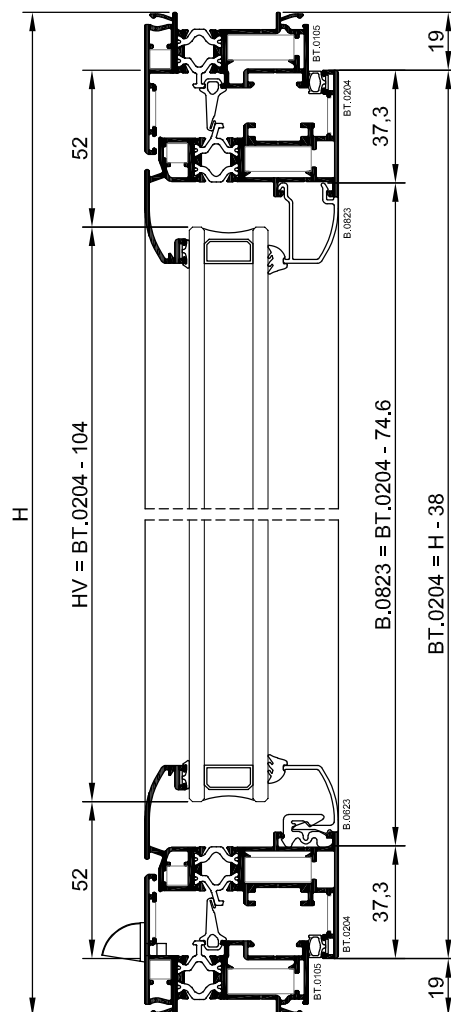





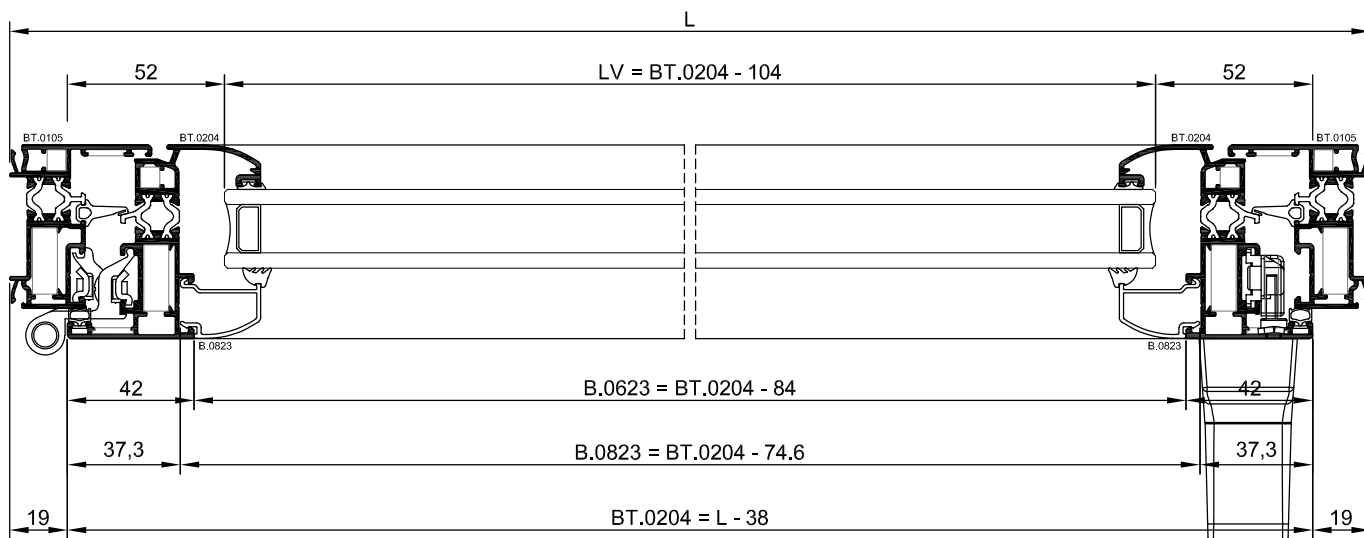

N.B.
Épaisseur vitrage considérée 26mm
L Vitrage = BT.0204 - 104
H Vitrage = BT.0204 - 104
1 pc

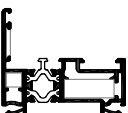
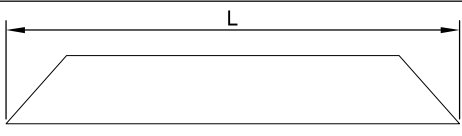
SEC. A-A

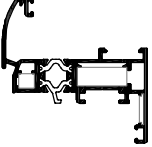
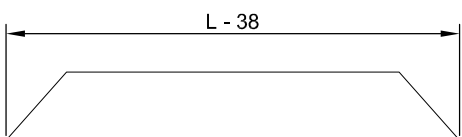
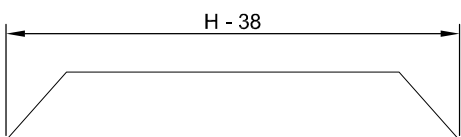

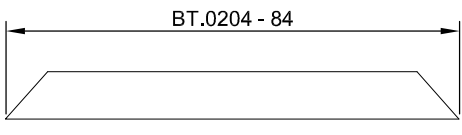
FENETRE BATTANT 1 VANTAIL

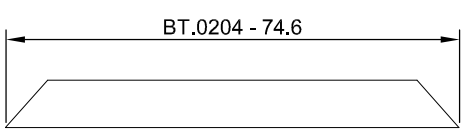
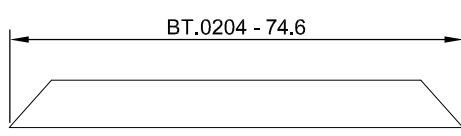
PROFILE	PCS	COUPE	PCS	COUPE
BT.0105 	2		2	
BT.0204 	2		2	
B.0623 	1			
B.0813 	1		2	

ACCESSORIES

REF.	DESCRIPTION	N.	REF.	DESCRIPTION	N.
0358	Équerre dormant_ouvrant	8	6008	Crémone Italia	1
0141	Équerre d'alignement dormant_ouvrant	8	2010.2B	Tringle	
0140	Goupil pour Équerre pour goupillage et sertissage	16	9211.3	Paumelle Top Rapid à deux corps	2*
PP2188.5	Équerre d'alignement dormant_ouvrant	8			
2145	Busette d'évacuation	2			
4032.63	Kit cremone 1 vantail	1			

JOINTS

REF.	DESCRIPTION	L	H	REF.	DESCRIPTION	L	H
IYS27-10	Central	2	2	CF4114	Vitrage interieur	2	2
SY3-247	Battement	2	2	SY4-11	Vitrage exterieur	2	2

*VUILLEZ CONSULTER LE TABLEAU DE CHARGE

FENETRE OSCILLOBATTANT 1 VANTAIL

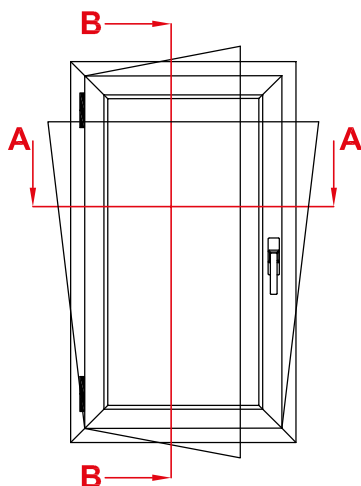

SEC. B-B

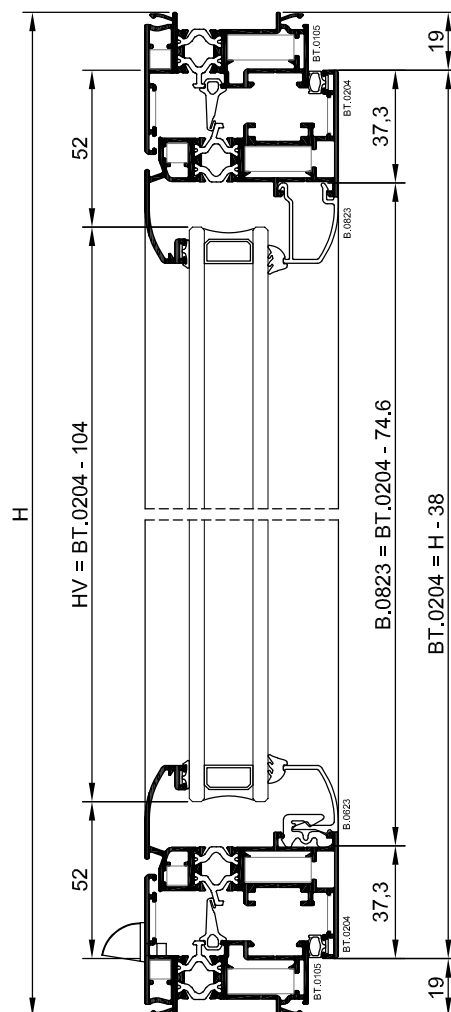



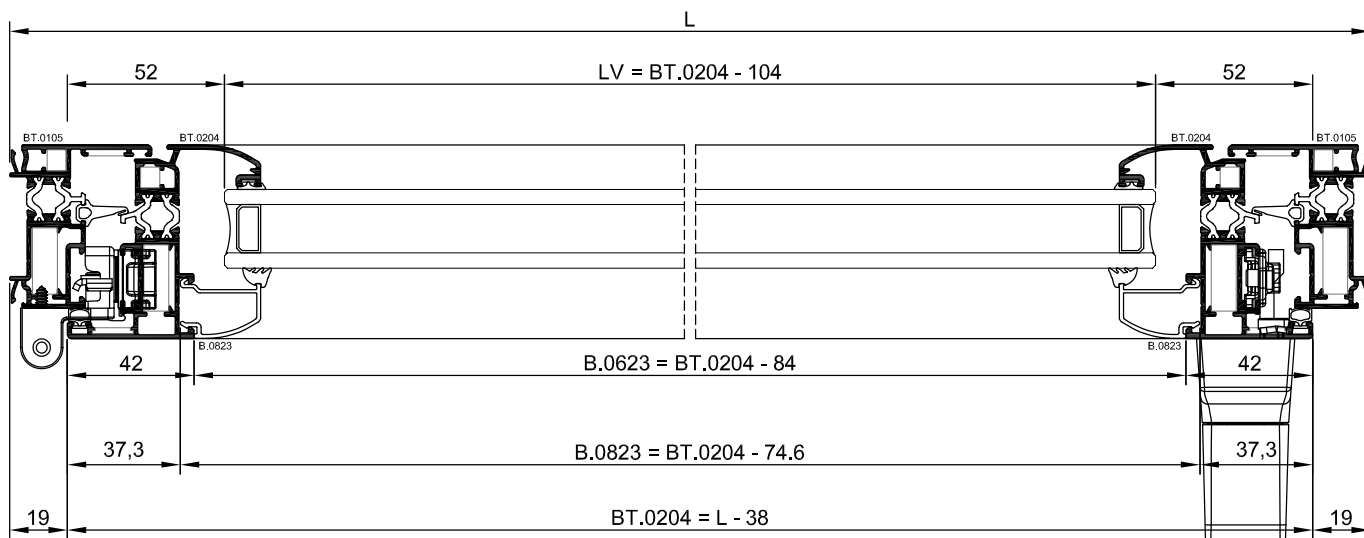

N.B.
 Épaisseur vitrage considérée 26mm
 L Vitrage = BT.0204 - 104
 H Vitrage = BT.0204 - 104
 1 pc

SEC. A-A

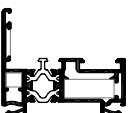
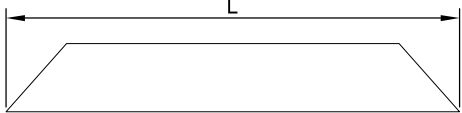
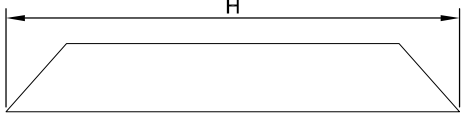
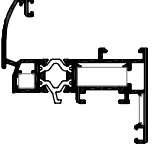
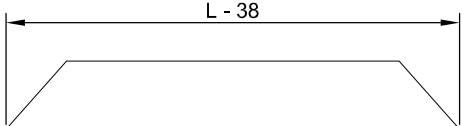
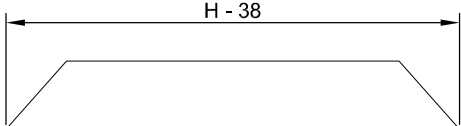

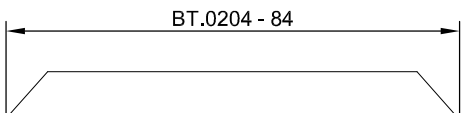
FENETRE OSCILLOBATTANT 1 VANTAIL

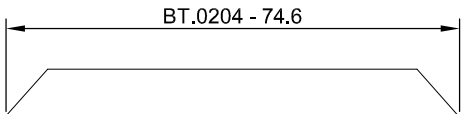
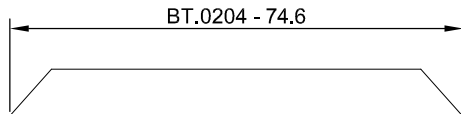
PROFILE	PCS	COUPE	PCS	COUPE
BT.0105 	2		2	
BT.0204 	2		2	
B.0623 	1			
B.0813 	1		2	

ACCESSORIES

REF.	DESCRIPTION	N.	REF.	DESCRIPTION	N.
0358	Équerre dormant_ouvrant	8	3420.24	Kit paumelle ob Ween - max 160kg	1
0141	Équerre d'alignement dormant_ouvrant	8	3400.2X	Bras ob Ween	1
0140	Goupil pour Équerre pour goupillage et sertissage	16	3420F.31	Point fermeture supplémentaire - H>1400mm	1
PP2188.5	Équerre d'alignement dormant_ouvrant	8	3400F.32	Point fermeture supplémentaire - H>2200mm	1
2145	Busette d'évacuation	2	3400.35	Fermeture horizontale Ween - L>1200 mm	1
3320F.1	Kit de fermeture Ween	1	6018	Crémone Italia p/oscillo battent	1
			2010.2B	Tringle	

JOINTS

REF.	DESCRIPTION	L	H	REF.	DESCRIPTION	L	H
IYS27-10	Central	2	2	CF4114	Vitrage interieur	2	2
SY3-247	Battement	2	2	SY4-11	Vitrage exterieur	2	2

FENETRE SOUFFLET

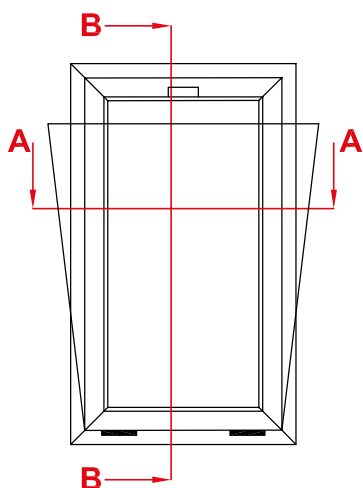

SEC. B-B

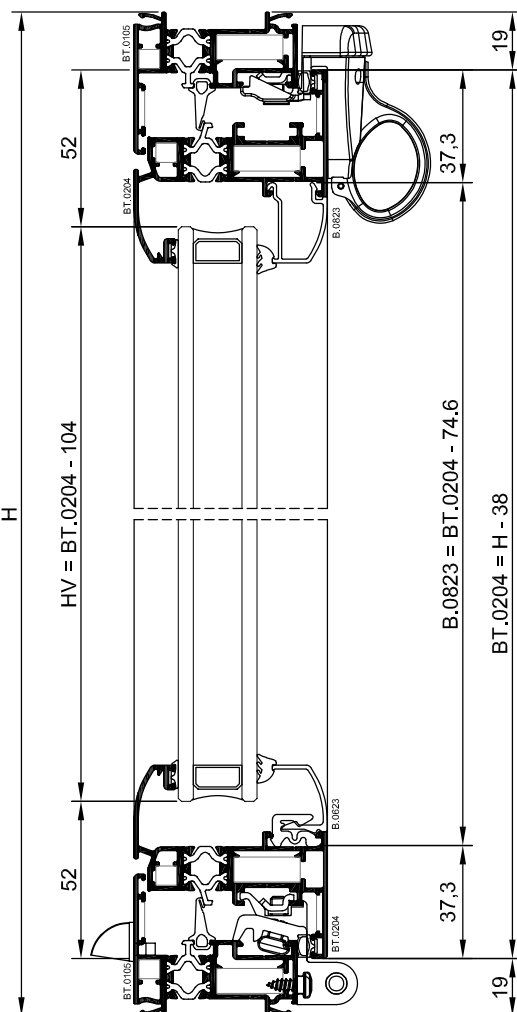



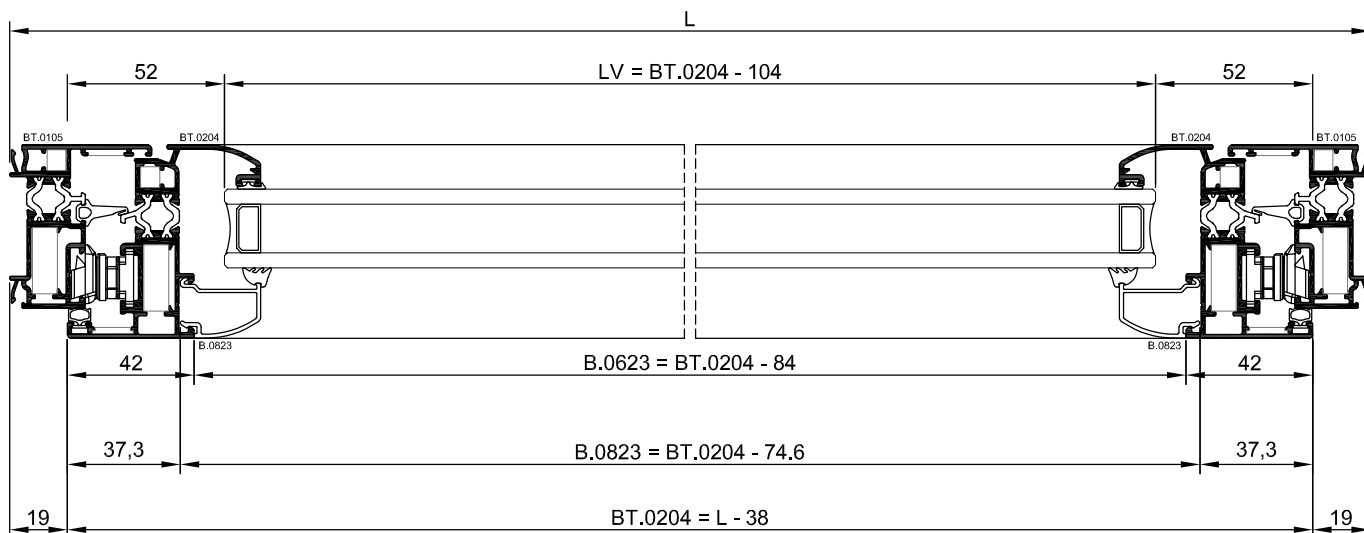

N.B.
 Épaisseur vitrage considérée 26mm
 L Vitrage = BT.0204 - 104
 H Vitrage = BT.0204 - 104
 1 pc

SEC. A-A

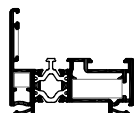
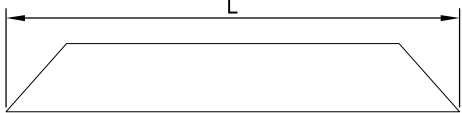
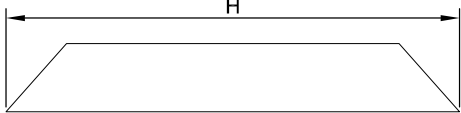
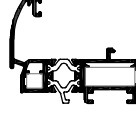
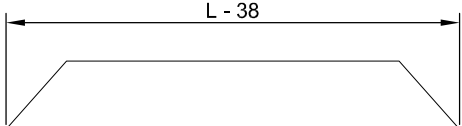
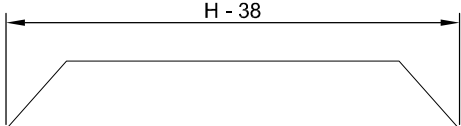

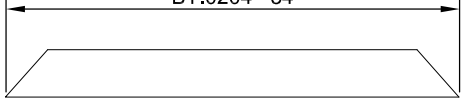
FENETRE SOUFFLET

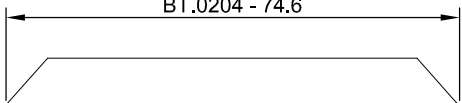
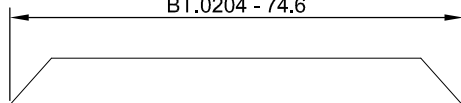
PROFILE	PCS	COUPE	PCS	COUPE
BT.0105 	2		2	
BT.0204 	2		2	
B.0623 	1			
B.0813 	1		2	

ACCESSORIES

REF.	DESCRIPTION	N.	REF.	DESCRIPTION	N.
0358	Equerre dormant_ouvrant	8	2145	Busette d'évacuation	2
0141	Equerre d'alignement dormant_ouvrant	8	1115.1	Bras limiteur d'ouverture vantail hauteur 600 à 1600	1 cp
0140	Goupil pour Équerre pour goupillage et sertissage	16	1500.5	Cliquet en zamak	1
PP2188.5	Equerre d'alignement dormant_ouvrant	8	3420.71	Paumelle à peigne	2*

JOINTS

REF.	DESCRIPTION	L	H	REF.	DESCRIPTION	L	H
IYS27-10	Central	2	2	CF4114	Vitrage interieur	2	2
SY3-247	Battement	2	2	SY4-11	Vitrage exterieur	2	2

*VUILLEZ CONSULTER LE TABLEAU DE CHARGE

FENETRE A L'ITALIENNE

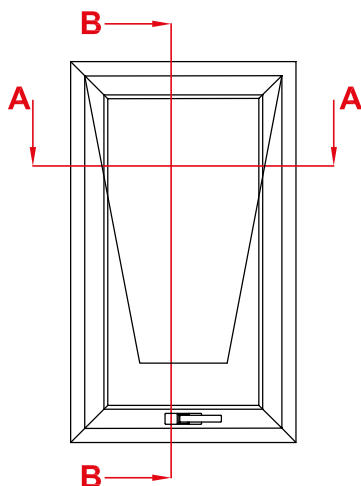

SEC. B-B

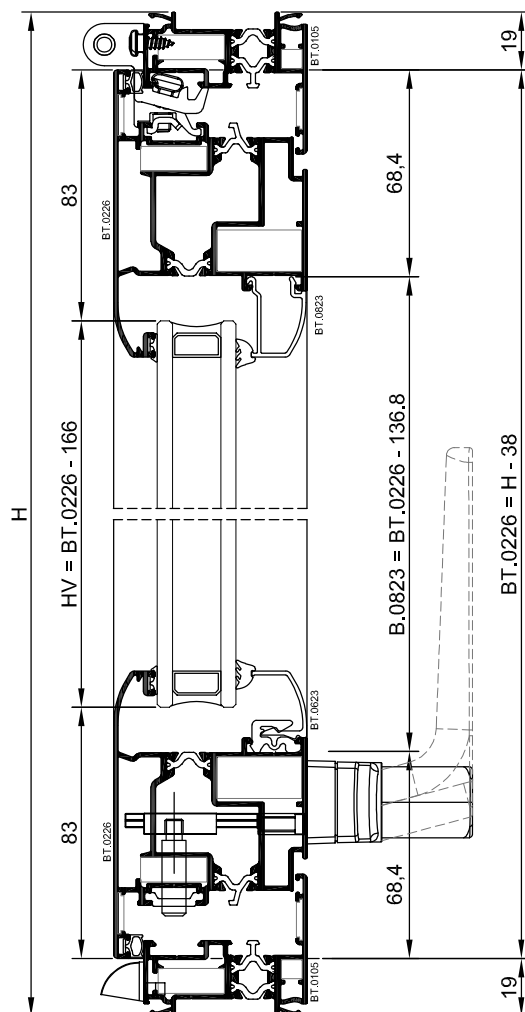





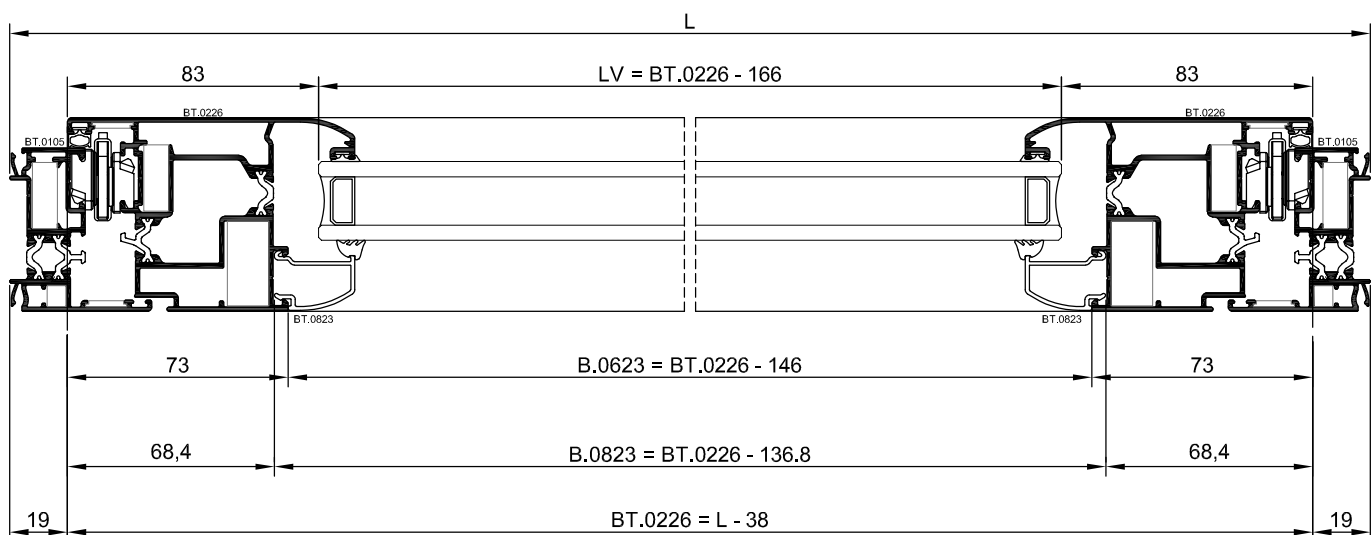

N.B.
 Épaisseur vitrage considérée 26mm
 L Vitrage = BT.0226 - 166
 H Vitrage = BT.0226 - 166
 1 pc

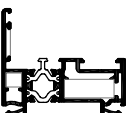
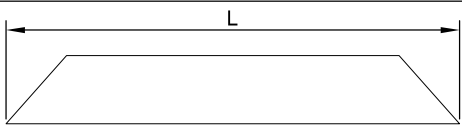
SEC. A-A

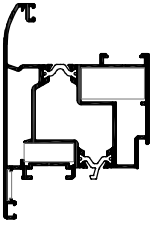
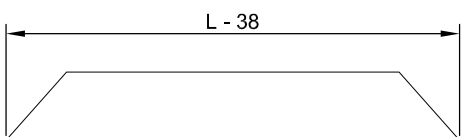
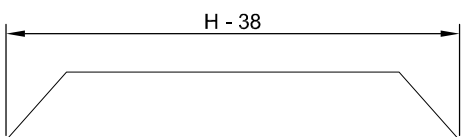

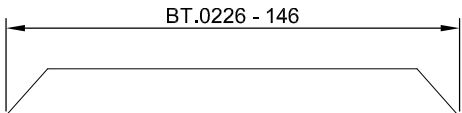
FENETRE A L'ITALIENNE

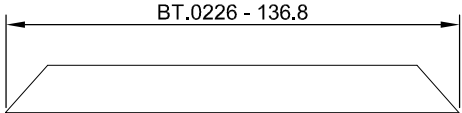
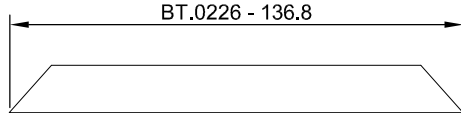
PROFILE	PCS	COUPE	PCS	COUPE
BT.0105 	2		2	
BT.0226 	2		2	
B.0623 	1			
B.0813 	1		2	

ACCESSORIES







REF.	DESCRIPTION	N.	REF.	DESCRIPTION	N.
0358	Equerre dormant_ouvrant	8	2010.2B	Tringle	
0141	Equerre d'alignement dormant	4	6065.3	Crémone ouverture externe Avec curseurs réglables	1
0140	Goupil pour Équerre pour goupillage et sertissage	8	6420E.25	Pivot de jonction (L=25mm)	2
PP2188.5	Equerre d'alignement dormant_ouvrant	8	3420.71	Paumelle à peigne	2*
0265.50	Equerre ouvrant	4	4207.21	Point fermeture additionnelle	2
2145	Busette d'évacuation	2	1210.1	Bras Télescopique à déclic	1 cp

JOINTS

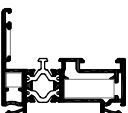
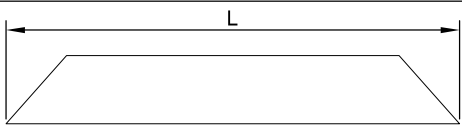
REF.	DESCRIPTION	L	H	REF.	DESCRIPTION	L	H
				CF4114	Vitrage interieur	2	2
SY3-247	Battement	2	2	SY4-11	Vitrage exterieur	2	2

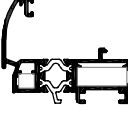
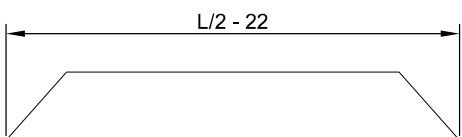
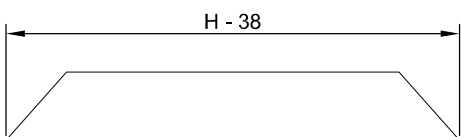
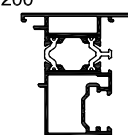
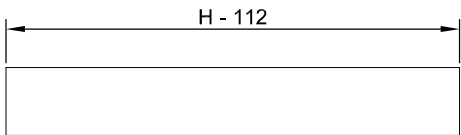
*VUILLEZ CONSULTER LE TABLEAU DE CHARGE

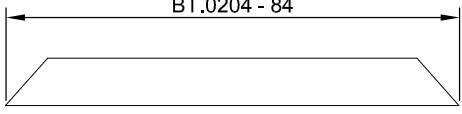
FENETRE BATTANT 2 VANTAUX

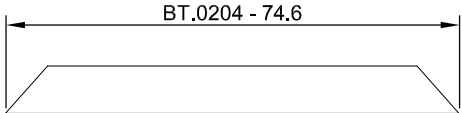
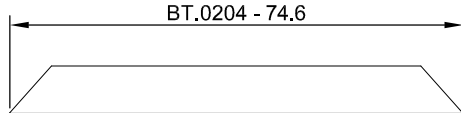
PROFILE	PCS	COUPE	PCS	COUPE
BT.0105 	2		2	
BT.0204 	4		4	
BT.0200 			1	
B.0623 	2			
B.0813 	2		4	

ACCESSORIES

REF.	DESCRIPTION	N.	REF.	DESCRIPTION	N.
0358	Equerre dormant_ouvrant	12	6008	Crémone Italia	1
0141	Equerre d'alignement dormant_ouvrant	12	2010.2B	Tringle	
0140	Goupil pour Équerre pour goupillage et sertissage	24	4515.1	Verrou a levier bi-directionnel	1
PP2188.5	Equerre d'alignement dormant_ouvrant	12	4206	Double gache crémone	2
2145	Busette d'évacuation	2	9211.3	Paumelle Top Rapid à deux corps	4*
4032.63	Kit cremone 1 vantail	1	PP2081.18	Embout battement central	1

JOINTS

REF.	DESCRIPTION	L	H	REF.	DESCRIPTION	L	H
IYS27-10	Central	2	3	CF4114	Vitrage interieur	4	4
SY3-247	Battement	4	4	SY4-11	Vitrage exterieur	4	4

*VUILLEZ CONSULTER LE TABLEAU DE CHARGE

FENETRE OSCILLOBATTANT 2 VANTAUX

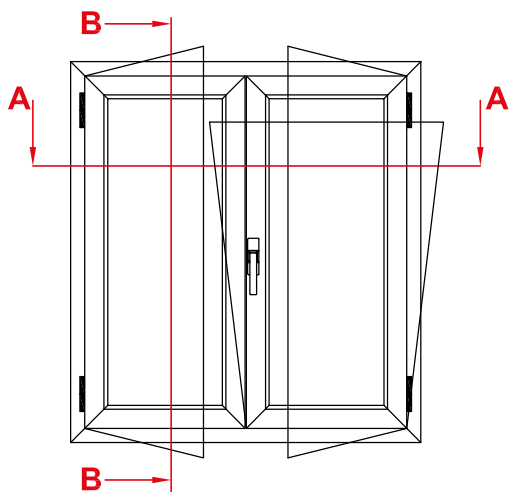

SEC. B-B

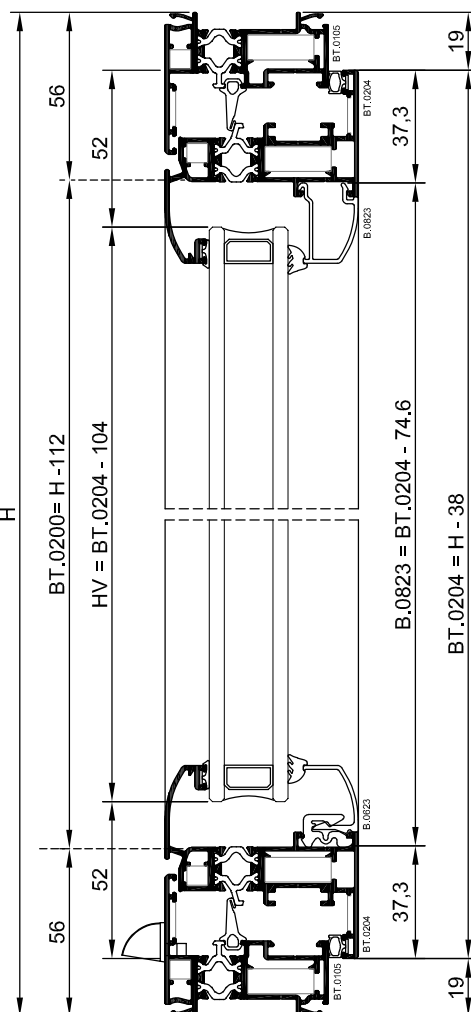





N.B.
Épaisseur vitrage considérée 26mm
L Vitrage = BT.0204 - 104
H Vitrage = BT.0204 - 104
2 pcs

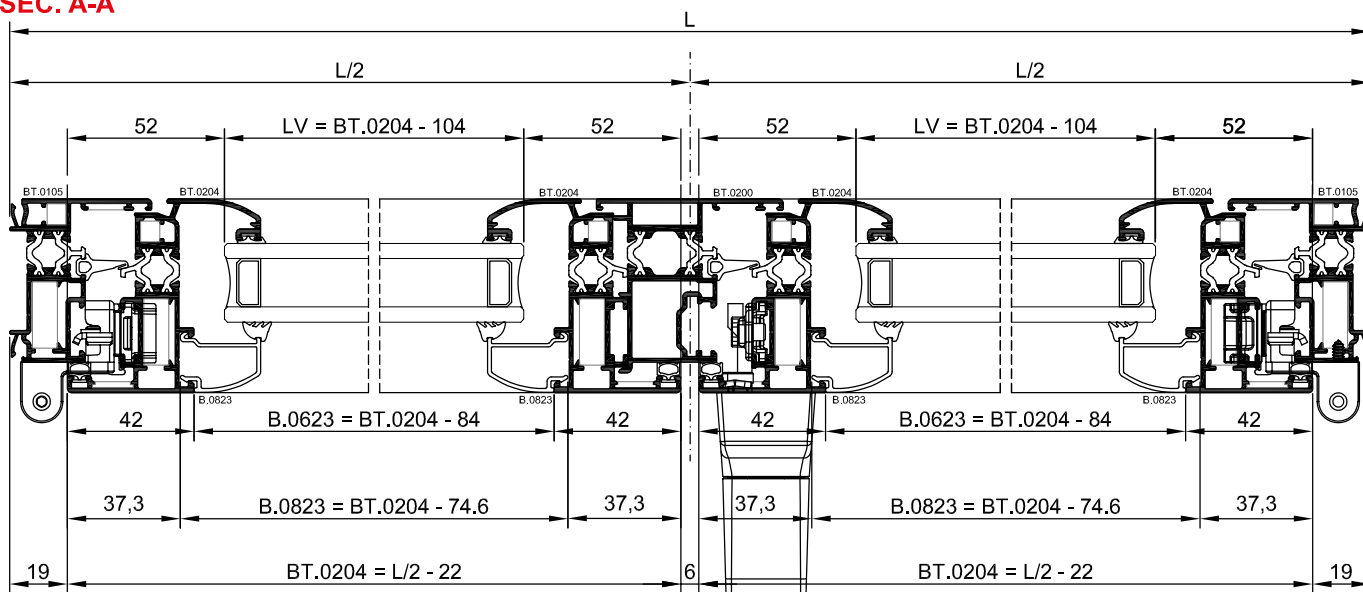

SEC. A-A

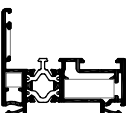
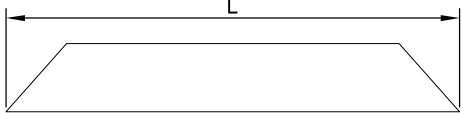
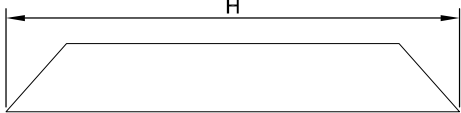
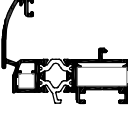
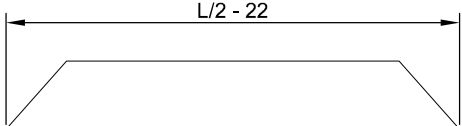
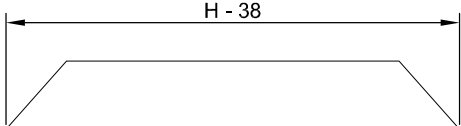
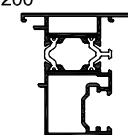
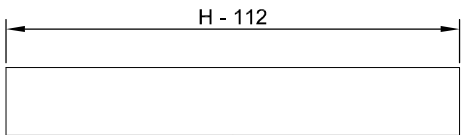

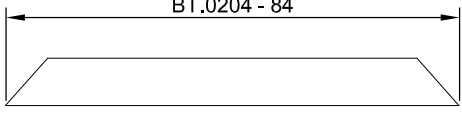
FENETRE OSCILLOBATTANT 2 VANTAUX

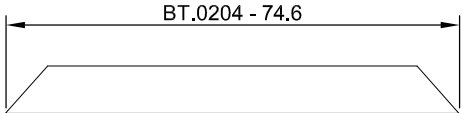
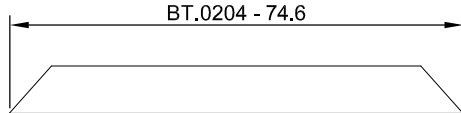
PROFILE	PCS	COUPE	PCS	COUPE
BT.0105 	2		2	
BT.0204 	4		4	
BT.0200 			1	
B.0623 	2			
B.0813 	2		4	

ACCESSORIES

REF.	DESCRIPTION	N.	REF.	DESCRIPTION	N.
0358	Equerre dormant_ouvrant	12	3400.2X	Bras ob Ween	1
0141	Equerre d'alignement dormant_ouvrant	12	3420F.31	Point fermeture supplémentaire - H>1400mm	1
0140	Goupil pour Équerre pour goupillage et sertissage	24	3400F.32	Point fermeture supplémentaire - H>2200mm	1
PP2188.5	Equerre d'alignement dormant_ouvrant	12	3400.35	Fermeture horizontale Ween - L>1200 mm	1
2145	Busette d'évacuation	2	6018	Crémone Italia p/oscillo battent	1
3320F.1	Kit de fermeture Ween	1	2010.2B	Tringle	
3420.23	Kit paumelle ob Ween vantail semi fixe - max 160kg	1	4515.1	Verrou a levier bi-directionnel	1
3420.24	Kit paumelle ob Ween - max 160kg	1	4206	Double gache crémone	1
			PP2081.18	Embout battement central	1

JOINTS

REF.	DESCRIPTION	L	H	REF.	DESCRIPTION	L	H
IYS27-10	Central	2	3	CF4114	Vitrage interieur	4	4
SY3-247	Battement	4	4	SY4-11	Vitrage exterieur	4	4

FENETRE BATTANT 2 VANTAUX (bas profile central)

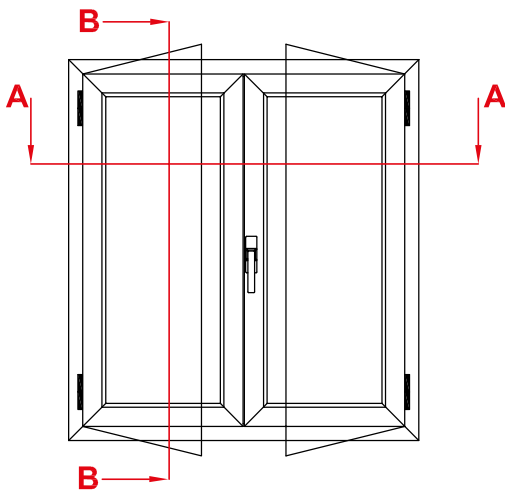

SEC. B-B

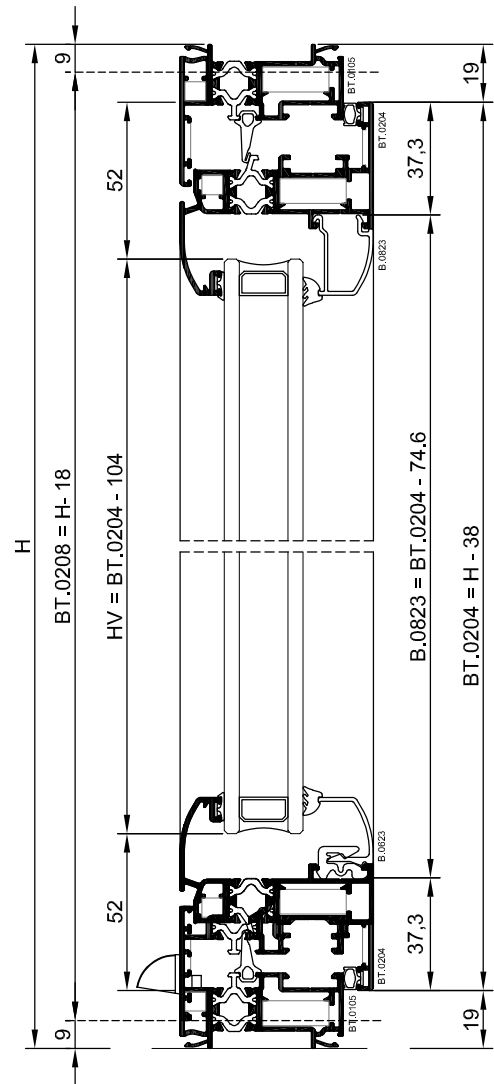





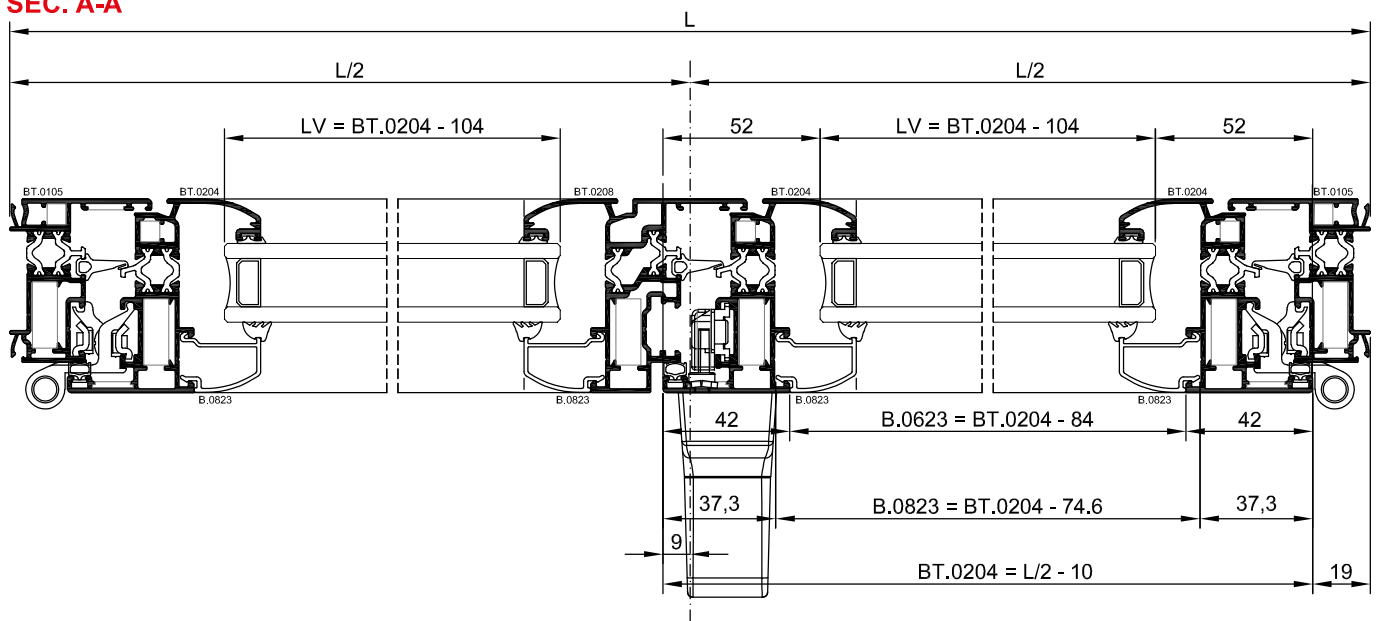

N.B.
 Épaisseur vitrage considérée 26mm
 L Vitrage = BT.0204 - 104
 H Vitrage = BT.0204 - 104
 2 pcs

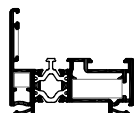
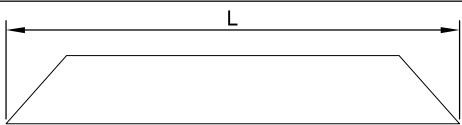
SEC. A-A

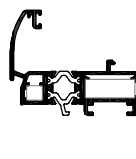
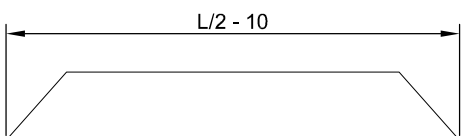
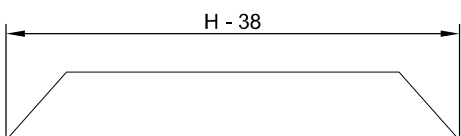
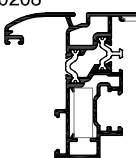
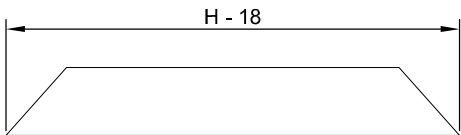

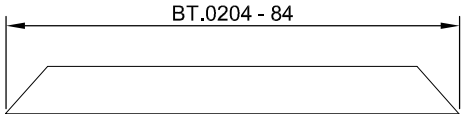
FENETRE BATTANT 2 VANTAUX (bas profile central)

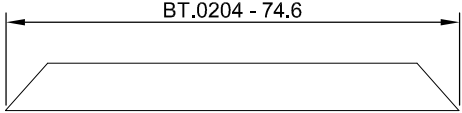
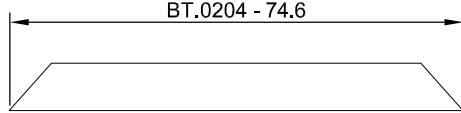
PROFILE	PCS	COUPE	PCS	COUPE
BT.0105 	2		2	
BT.0204 	4		3	
BT.0208 			1	
B.0623 	2			
B.0813 	2		4	

ACCESSORIES

REF.	DESCRIPTION	N.	REF.	DESCRIPTION	N.
0358	Equerre dormant_ouvrant	12	6008	Crémone Italia	1
0141	Equerre d'alignement dormant_ouvrant	10	2010.2B	Tringle	
0140	Goupil pour Équerre pour goupillage et sertissage	20	4515.1	Verrou a levier bi-directionnel	1
PP2188.5	Equerre d'alignement dormant_ouvrant	10	4206	Double gache crémone	2
2145	Busette d'évacuation	2	9211.3	Paumelle Top Rapid à deux corps	4*
4032.63	Kit cremone 1 vantail	1	PP2081.19	Embout bettement central réduit	1

JOINTS

REF.	DESCRIPTION	L	H	REF.	DESCRIPTION	L	H
IYS27-10	Central	2	3	CF4114	Vitrage interieur	4	4
SY3-247	Battement	4	4	SY4-11	Vitrage exterieur	4	4

*VUILLEZ CONSULTER LE TABLEAU DE CHARGE

FENETRE OSCILLOBATTANT 2 VANTAUX (bas profile central)

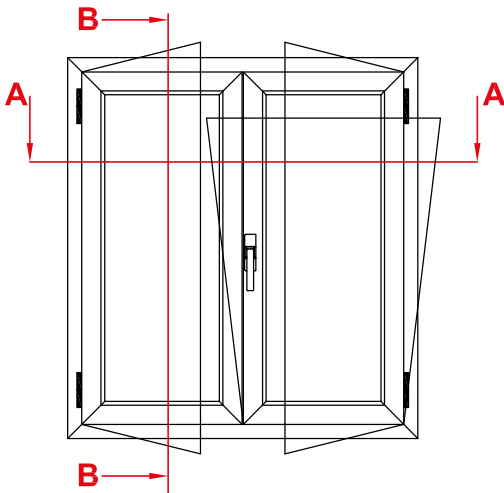

SEC. B-B

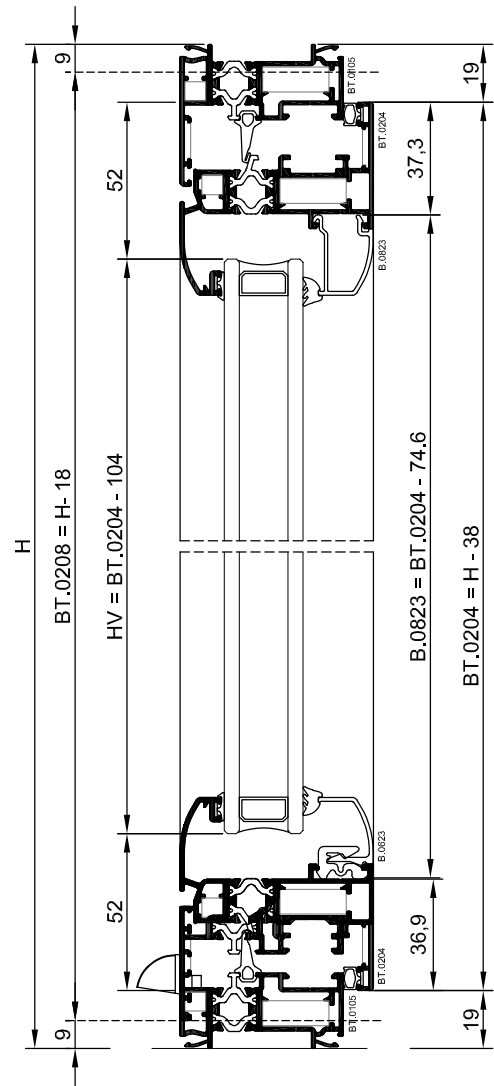





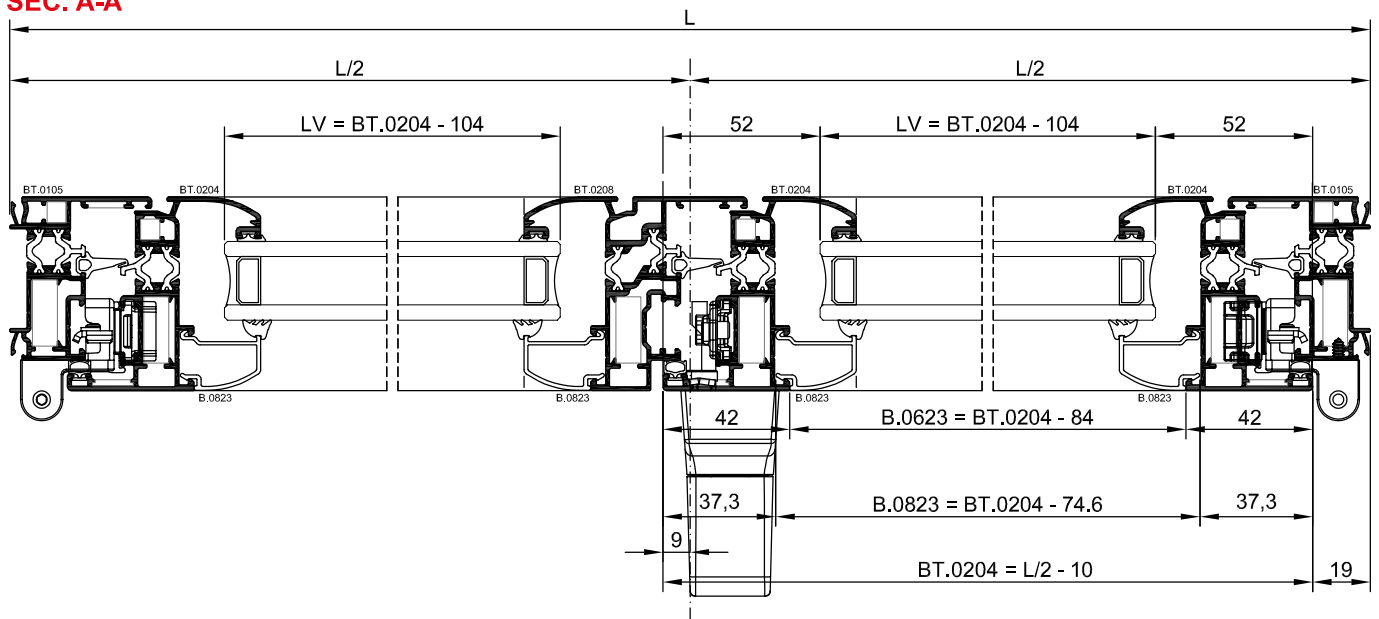

N.B.
 Épaisseur vitrage considérée 26mm
 L Vitrage = BT.0204 - 104
 H Vitrage = BT.0204 - 104
 2 pcs

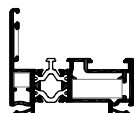
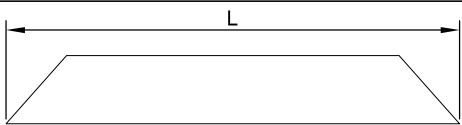
SEC. A-A

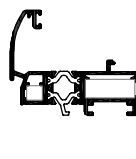
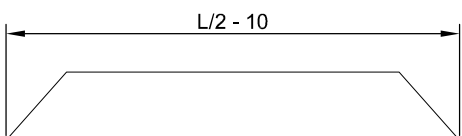
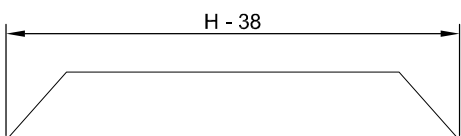
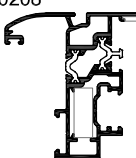
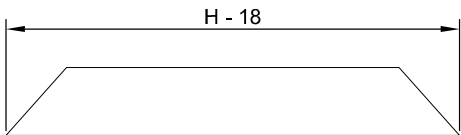

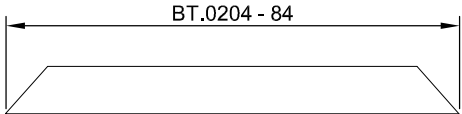
FENETRE OSCILLOBATTANT 2 VANTAUX (bas profile central)

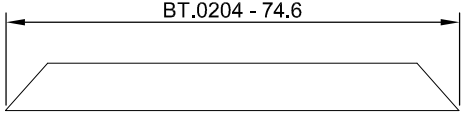
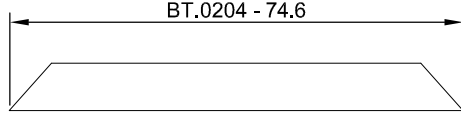
PROFILE	PCS	COUPE	PCS	COUPE
BT.0105 	2		2	
BT.0204 	4		3	
BT.0208 			1	
B.0623 	2			
B.0813 	2		4	











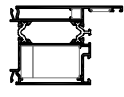
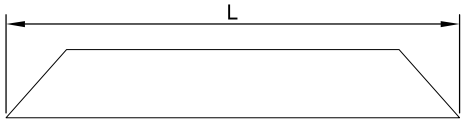

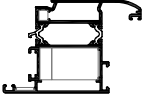
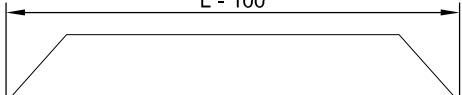
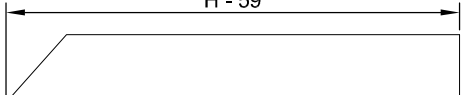
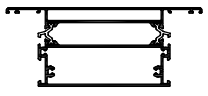
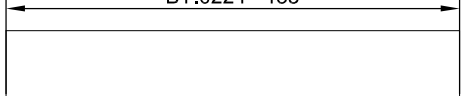
ACCESSORIES

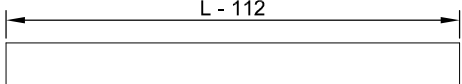
REF.	DESCRIPTION	N.	REF.	DESCRIPTION	N.
0358	Equerre dormant_ouvrant	12	3400.2X	Bras ob Ween	1
0141	Equerre d'alignement dormant_ouvrant	10	3420F.31	Point fermeture supplémentaire - H>1400mm	1
0140	Goupil pour Équerre pour goupillage et sertissage	20	3400F.32	Point fermeture supplémentaire - H>2200mm	1
PP2188.5	Equerre d'alignement dormant_ouvrant	10	3400.35	Fermeture horizontale Ween - L>1200 mm	1
2145	Busette d'évacuation	2	6018	Crémone Italia p/oscillo battent	1
3320F.1	Kit de fermeture Ween	1	2010.2B	Tringle	
3420.23	Kit paumelle ob Ween vantail semi fixe - max 160kg	1	4515.1	Verrou a levier bi-directionnel	1
3420.24	Kit paumelle ob Ween - max 160kg	1	4206	Double gache crémone	1
			PP2081.19	Embout bettement central réduit	1

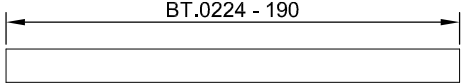
JOINTS

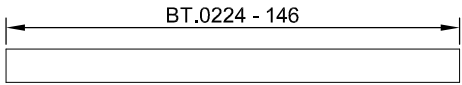
REF.	DESCRIPTION	L	H	REF.	DESCRIPTION	L	H
IYS27-10	Central	2	3	CF4114	Vitrage interieur	4	4
SY3-247	Battement	4	4	SY4-11	Vitrage exterieur	4	4

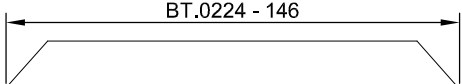
PORTE OUVERTURE INTERIEUR 1 VANTAIL

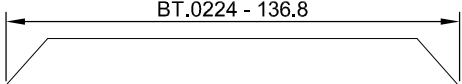
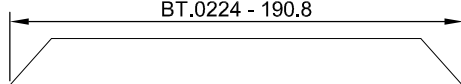
PROFILE	PCS	COUPE	PCS	COUPE
BT.0125 	1		2	
BT.0224 	1		2	
BT.0330 	1			
B.0332 	1			
B.0050 	1			
B.0060 	1			
B.0623 	1			
B.0813 	1		2	

ACCESSORIES

REF.	DESCRIPTION	N.	REF.	DESCRIPTION	N.
0358	Equerre dormant_ouvrant	8	5303.6	Contreplaque réglable pour serrure multipoints	1
028X	Supplément equerre dormant_ouvrant 21.9x31.7 mm	8	3065	Double bequille Italia	1
0141	Equerre d'alignement dormant_ouvrant	8	2129.4	Cache cylindre Italia	2
0140	Goupil pour Équerre pour goupillage et sertissage	16	2010.2B	Tringle	
PP2188.5	Equerre d'alignement dormant_ouvrant	8	4032.20	Embout de tringle	1
8060	Paumelle Slim Rapid à deux corps	2*	4202.1	Gâche simple	1
5300.35	Serrure multipoints pour montant bidirectionnel	1	4032B.20	Embout de tringle	1
			4234	Gâche à puits	1

JOINTS

REF.	DESCRIPTION	L	H	REF.	DESCRIPTION	L	H
IYS27-10	Central	1	2	CF4114	Vitrage interieur	2	2
SY3-247	Battement	2	2	SY4-11	Vitrage exterieur	2	2

*VUILLEZ CONSULTER LE TABLEAU DE CHARGE

PORTE OUVERTURE INTERIEUR 2 VANTAUX

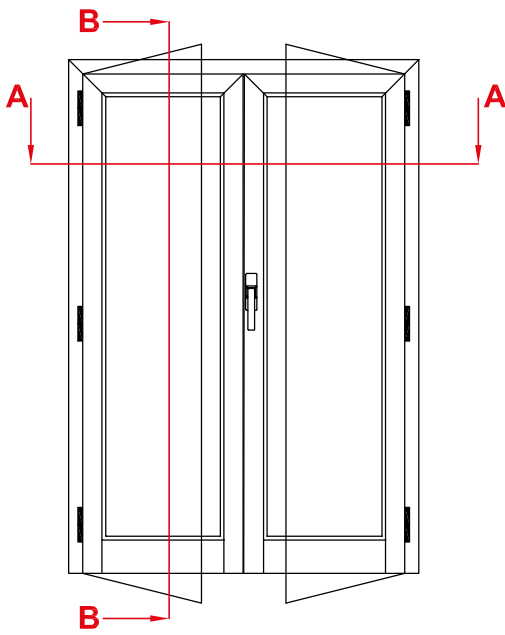

SEC. B-B





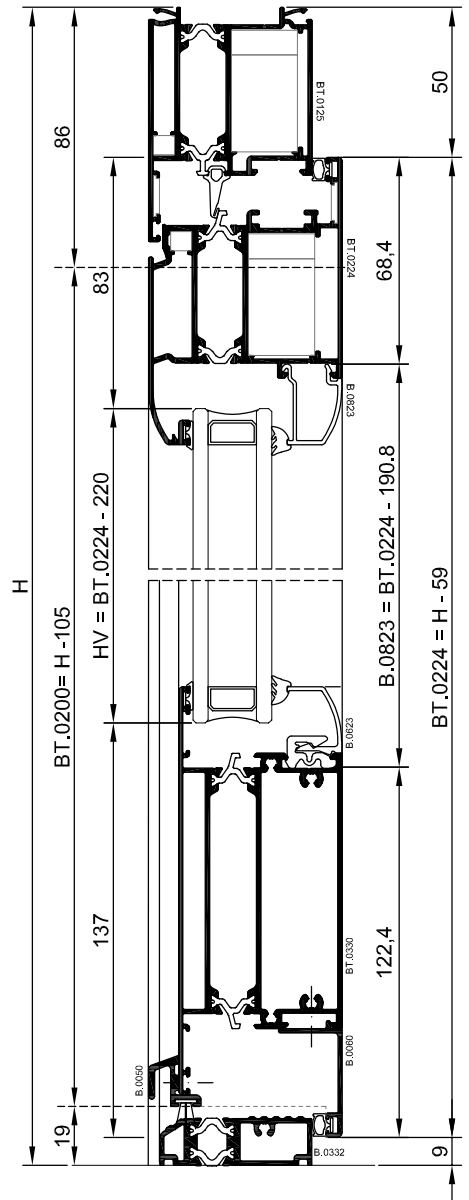



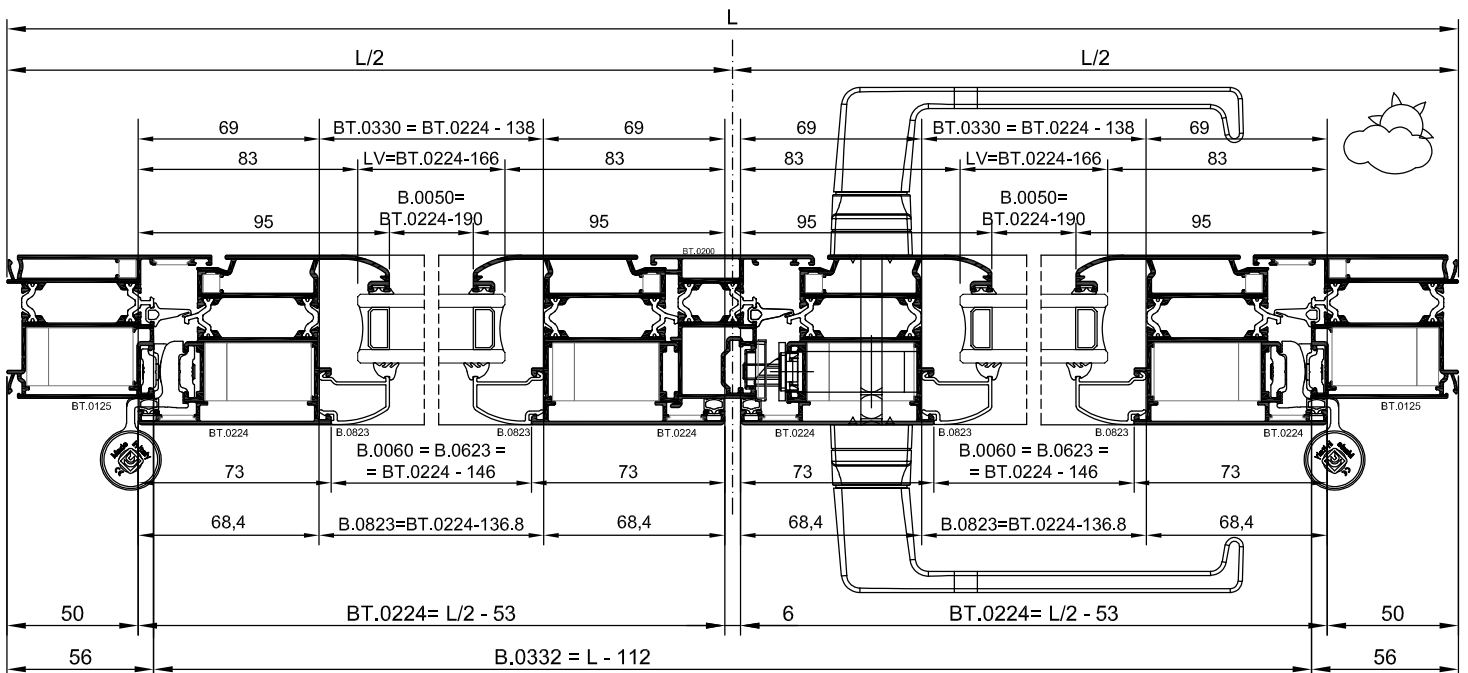

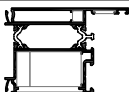
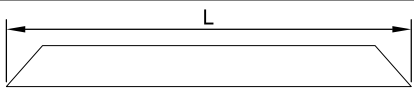

N.B.
Épaisseur vitrage considérée 26mm
L Vitrage = BT.0224 - 166
H Vitrage = BT.0224 - 220
2pcs

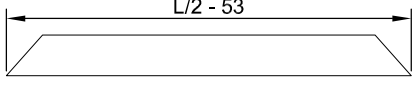
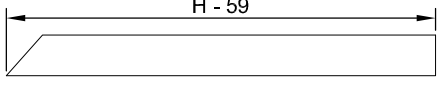
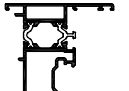
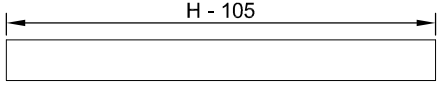
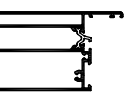
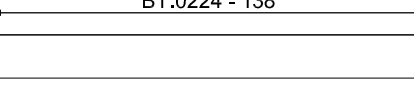
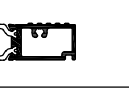
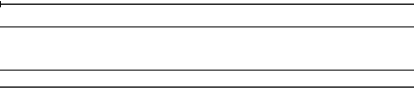

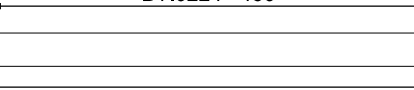
SEC. A-A

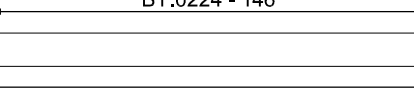

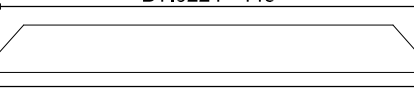
PORTE OUVERTURE INTERIEUR 1 VANTAIL

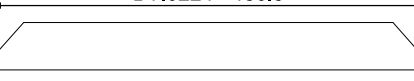
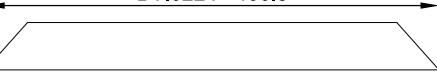
PROFILE	PCS	COUPE	PCS	COUPE
BT.0125 	1		2	
BT.0224 	2		4	
BT.0200 			1	
BT.0330 	2			
B.0332 	1			
B.0050 	2			
B.0060 	2			
B.0623 	2			
B.0813 	2		4	

ACCESSORIES

*VUILLEZ CONSULTER LE TABLEAU DE CHARGE

REF.	DESCRIPTION	N.	REF.	DESCRIPTION	N.
0358	Equerre dormant_ouvrant	6	2129.4	Cache cylindre Italia	
028X	Supplément equerre dormant_ouvrant 21.9x31.7 mm	6	2010.2B	Tringle	2
0141	Equerre d'alignement dormant_ouvrant	6	4032.20	Embout de tringle	1
0140	Goupil pour Équerre pour goupillage et sertissage	12	4206	Double gâche	1
PP2188.5	Equerre d'alignement dormant_ouvrant	6	4032B.20	Embout de tringle	1
8060	Paumelle Slim Rapid à deux corps	4*	4234	Gâche à puits	2
5300.35	Serrure multipoints pour montant bidirectionnel	1	4011.20	Verrou à commande directe (semi fixe fenêtre)	1
5303.6	Contreplaque réglable pour serrure multipoints	1	4011B.20	Verrou à commande directe (semi fixe fenêtre)	1
3065	Double bequille Italia	1	PP2081.18	Embout battement central	1

REF.	DESCRIPTION	L	H	REF.	DESCRIPTION	L	H
IYS27-10	Central	1	2	CF4114	Vitrage interieur	2	2
SY3-247	Battement	2	2	SY4-11	Vitrage exterieur	2	2

PORTE OUVERTURE COULISSANT PARALLELE 1 VANTAIL+FIXE

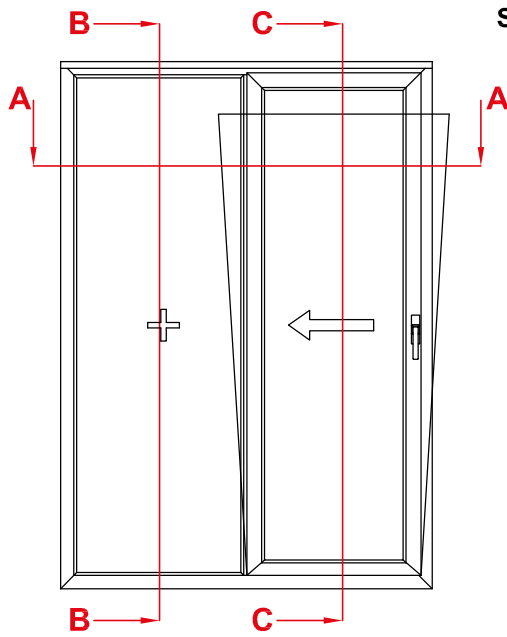

SEC. B-B

SEC. C-C

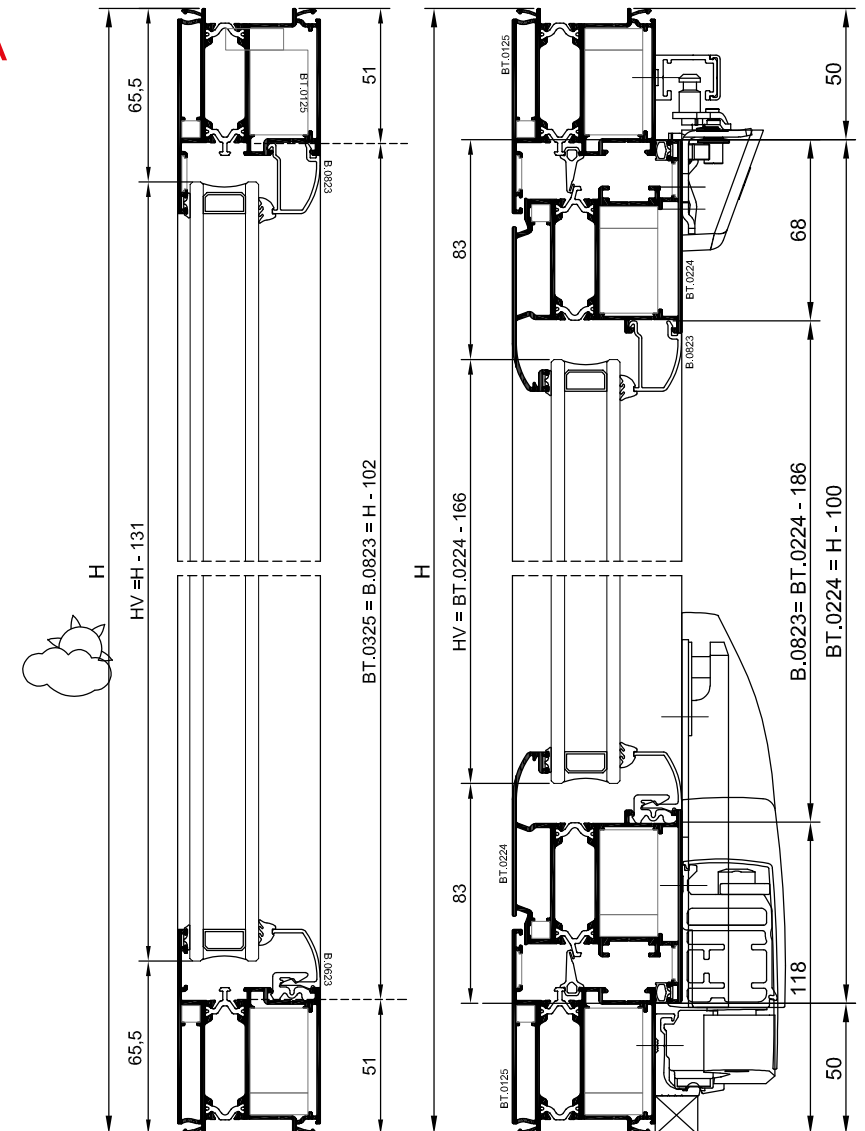

N.B.
Épaisseur vitrage considérée 26mm
L Vitrage = BT.0224 - 166
H Vitrage = BT.0224 - 206





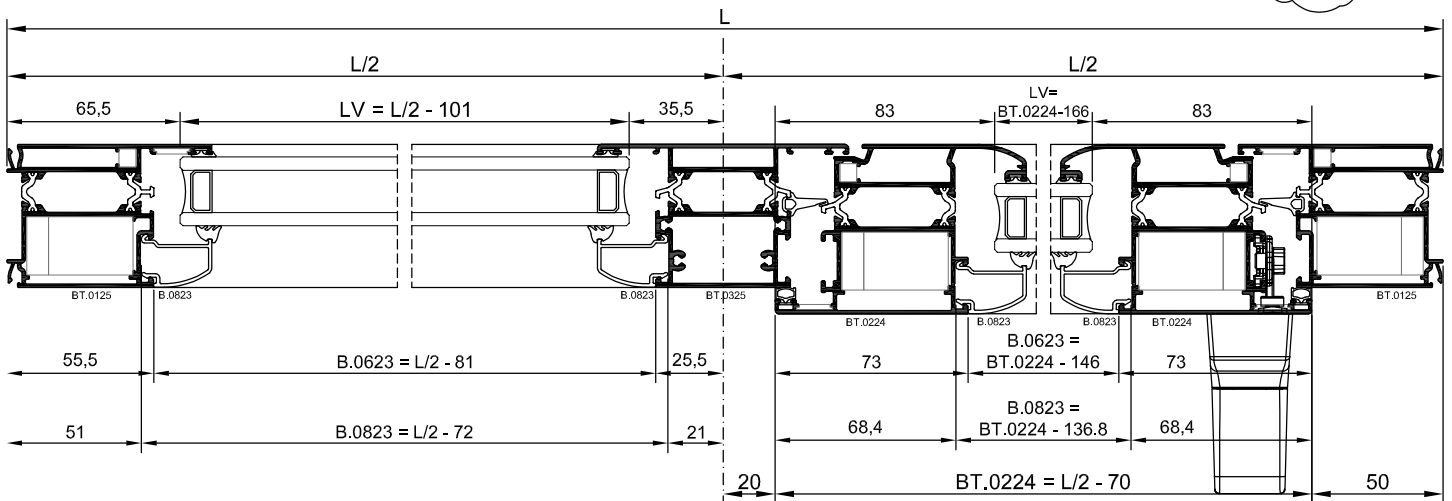

N.B.
Épaisseur vitrage considérée 26mm
L Vitrage Fixe = L/2 - 101
H Vitrage Fixe = H - 131

SEC. A-A

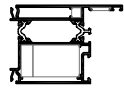
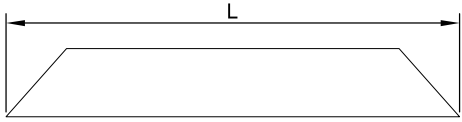

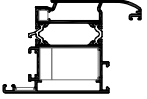
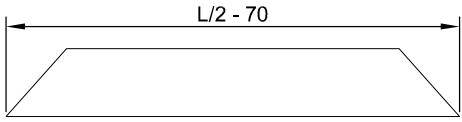
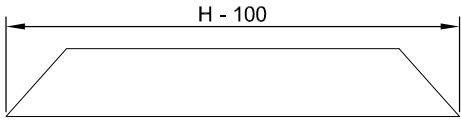
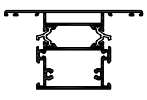
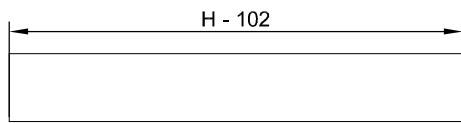
*POUR PLUS D'INFORMATIONS CONCERNANT L'USINAGE, VEUILLEZ CONSULTER LE SCHEMA DE MONTAGE SP160

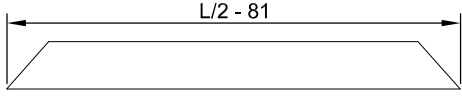
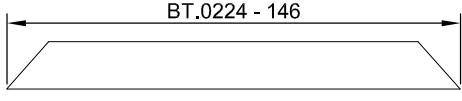
PORTE OUVERTURE COULISSANT PARALLELE 1 VANTAIL+FIXE

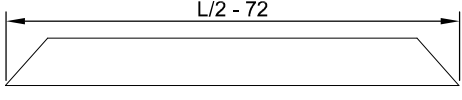
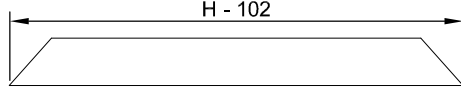
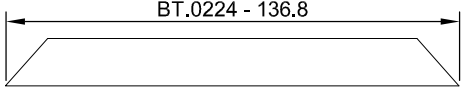
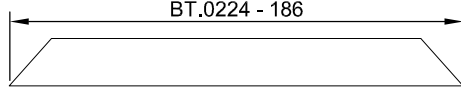
PROFILE	PCS	COUPE	PCS	COUPE
BT.0125 	2		2	
BT.0224 	2		2	
BT.0325 			1	
B.0623 	1			
	1			
B.0813 	1		2	
	1		2	

ACCESSORIES

REF.	DESCRIPTION	N.	REF.	DESCRIPTION	N.
0358	Equerre dormant_ouvrant	8	3900.200D/S	Paire chariots pour couissant parallele droite	1cp
028X	Supplément equerre dormant_ouvrant 21.9x31.7 mm	8	3915	Kit compas couissant parallele	1
0141	Equerre d'alignement dormant_ouvrant	8	3910.12	Kit cover pour chariots et compas	1
0140	Goupil pour Équerre pour goupillage et sertissage	16	3940.1X	Kit profiles	1
PP2188.5	Equerre d'alignement dormant_ouvrant	8	6018.41	Cremona ITALIA	1
3920.2	Kit couissant parallele semi-automatique	1	2010.2B	Tringle	

JOINTS

REF.	DESCRIPTION	L	H	REF.	DESCRIPTION	L	H
IYS27-10	Central	2	2	CF4114	Vitrage interieur	4	4
SY3-247	Battement	2	2	SY4-11	Vitrage exterieur	4	4

*POUR PLUS D'INFORMATIONS CONCERNANT L'USINAGE, VEUILLEZ CONSULTER LE SCHEMA DE MONTAGE SP160

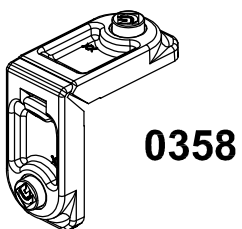
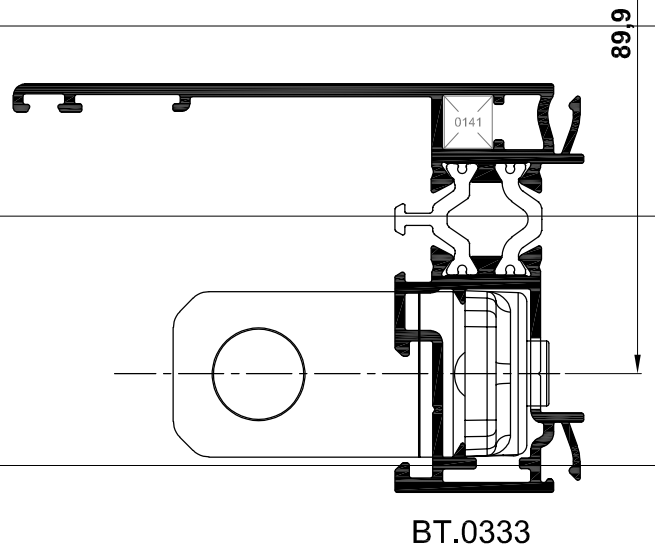
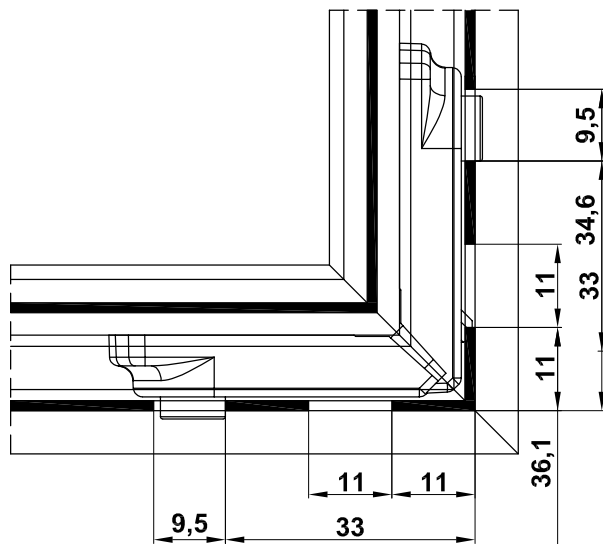
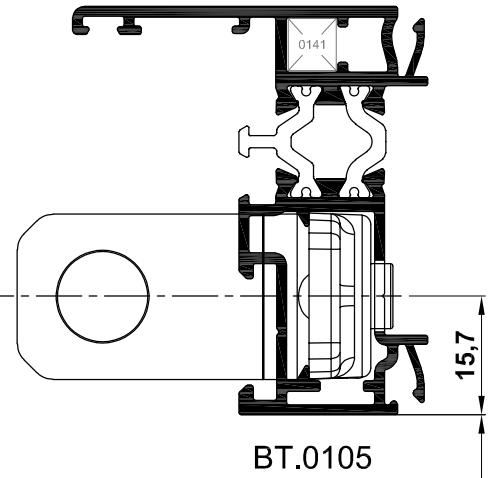
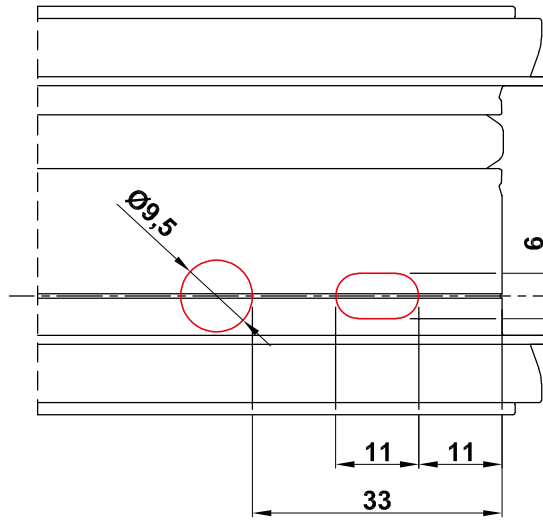

scale 1:1

Outil : Bloc outil / Perceuse

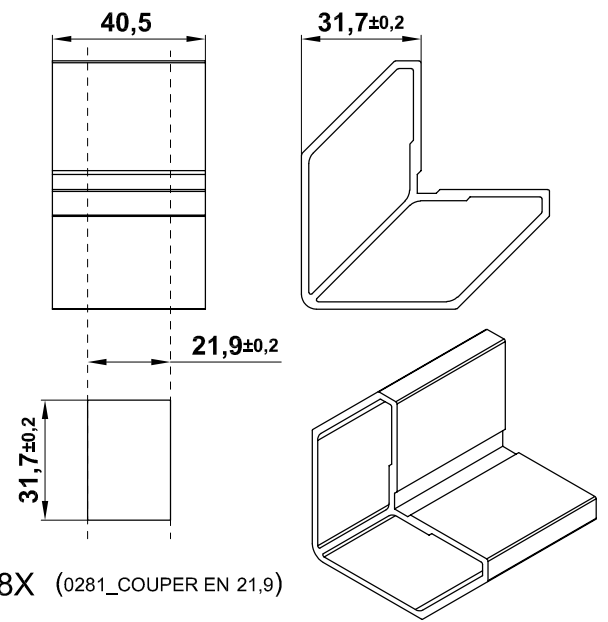
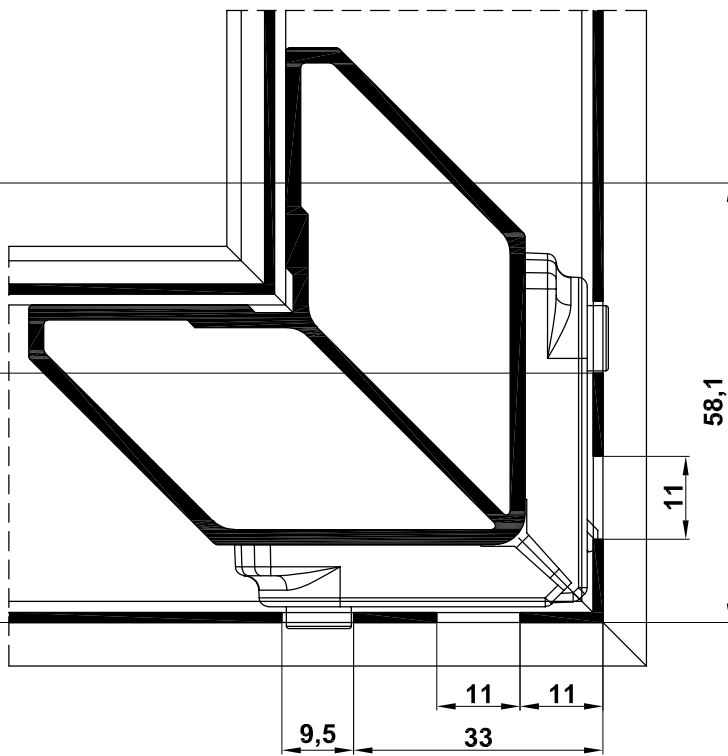
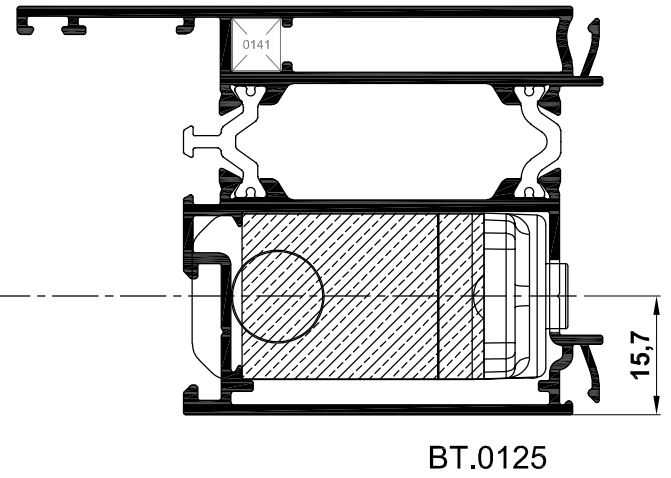
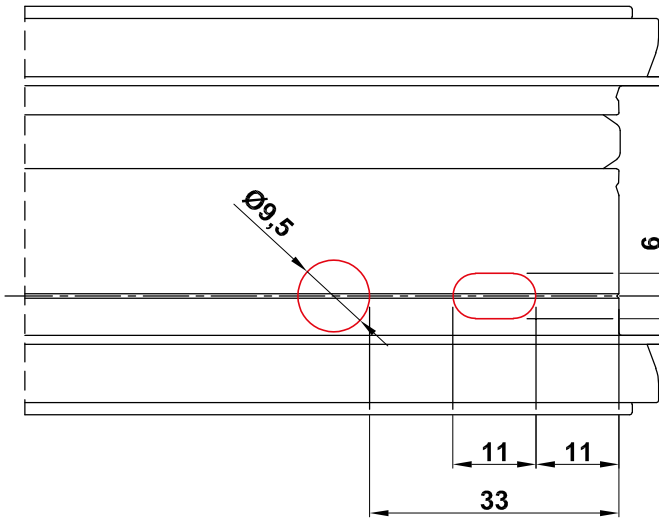

scale 1:2

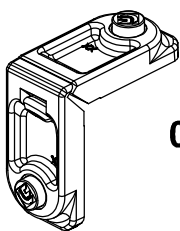

0358 combined with corner joint spacer

scale 1:1

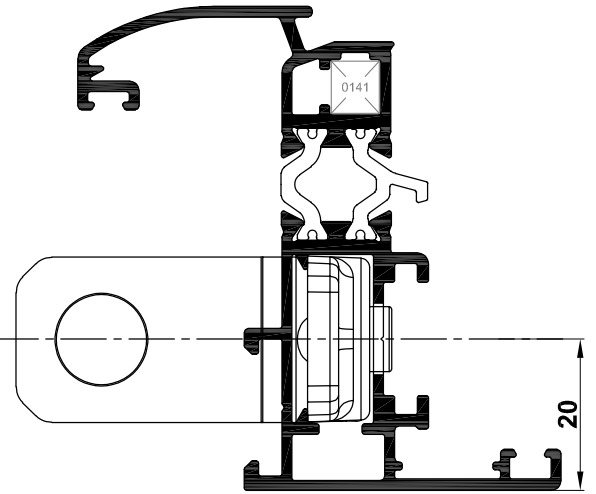
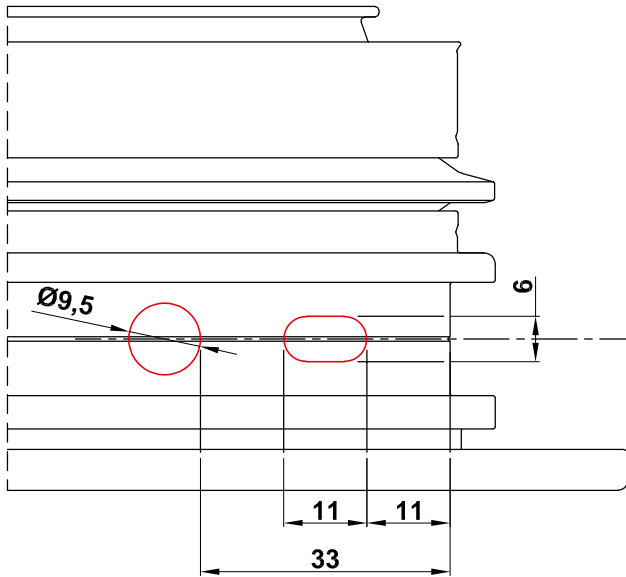

BT.0204

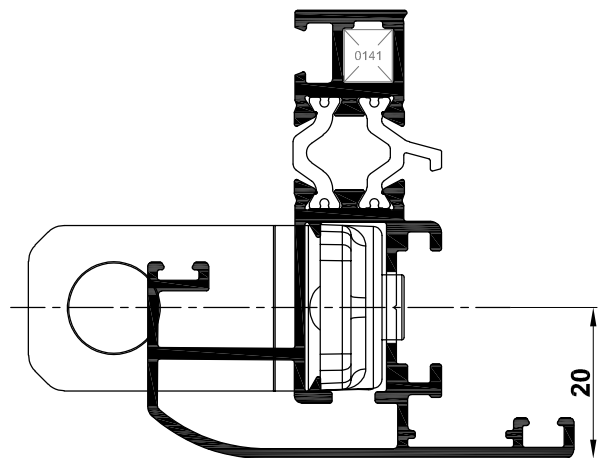
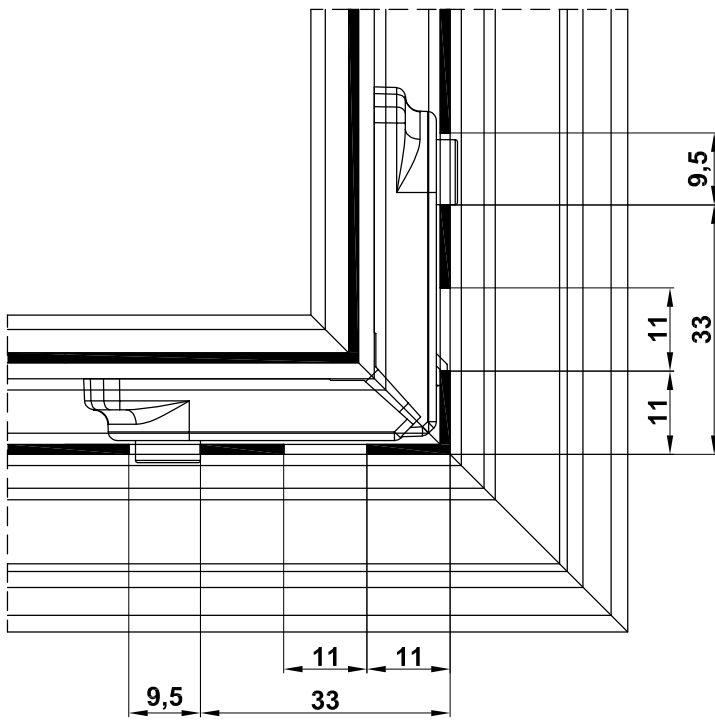

BT.0224

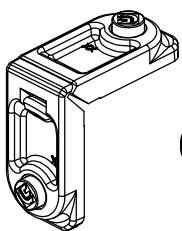

0358

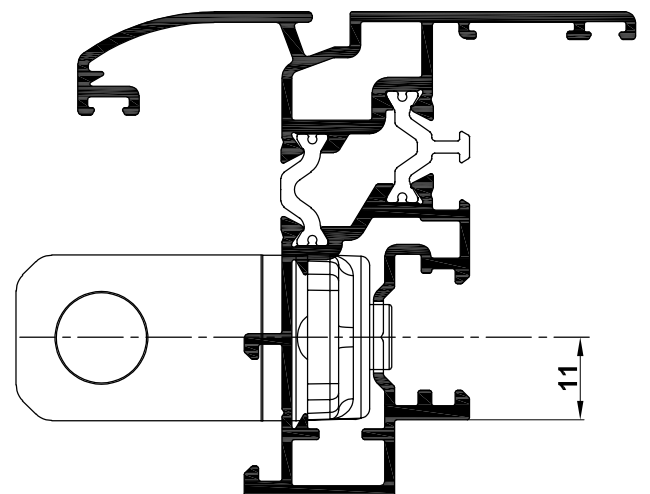

BT.0208

scale 1:1

Outil : Perceuse

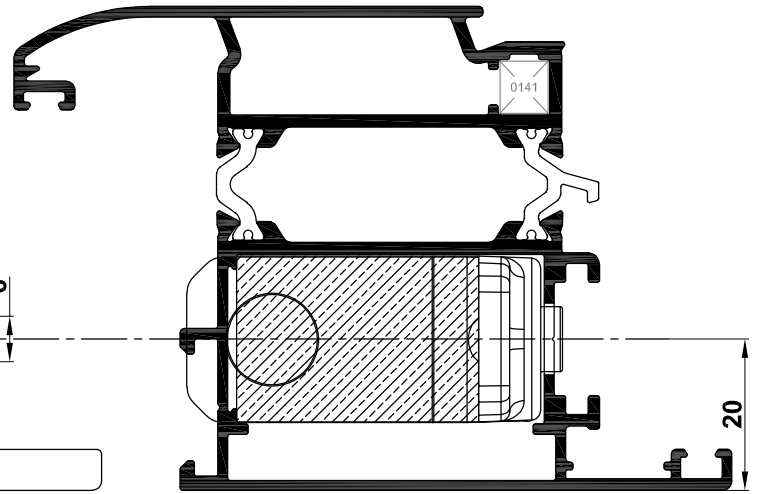
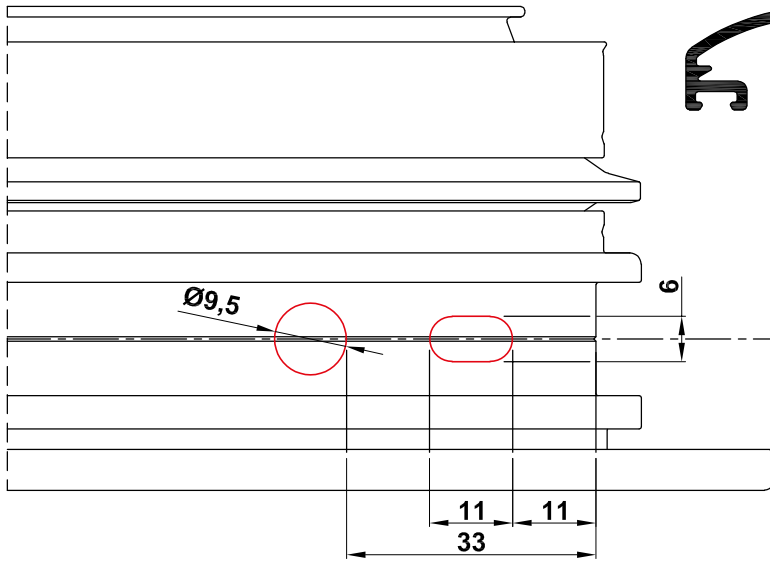

BT.0224

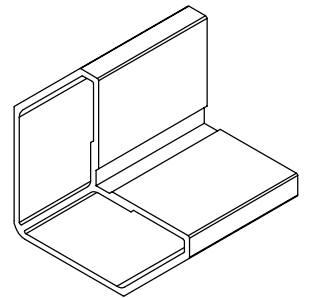
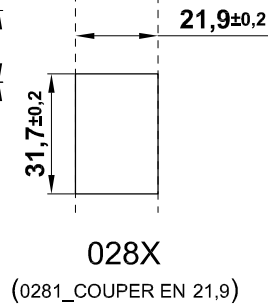
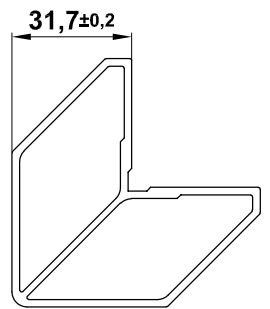
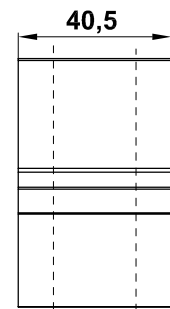
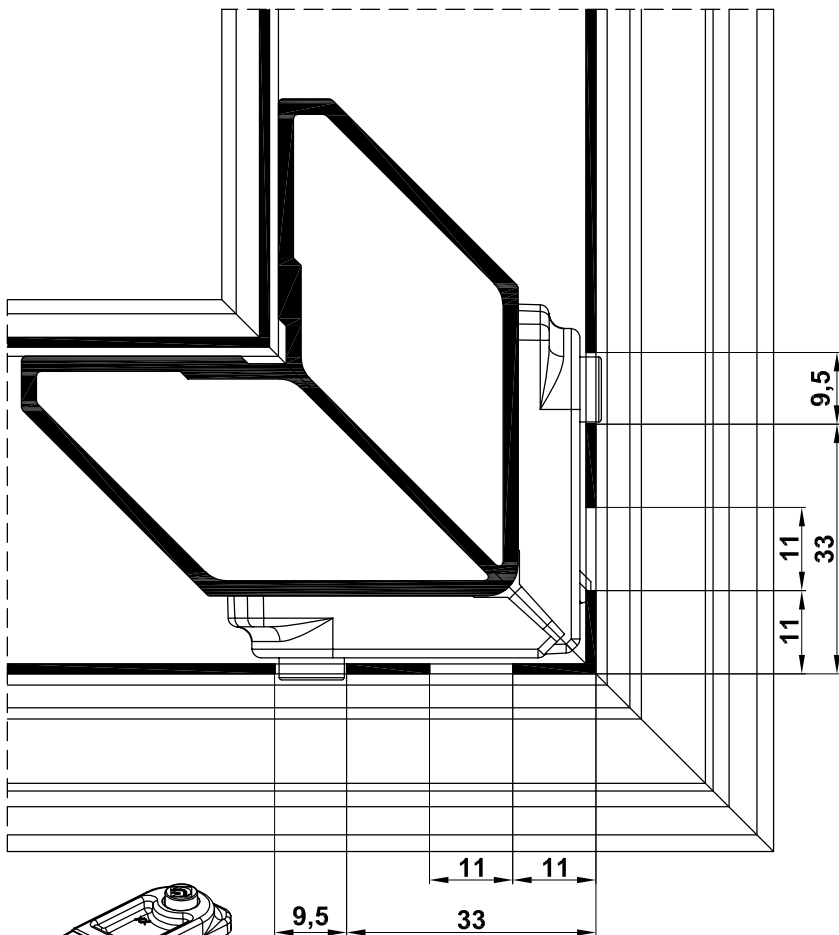

scale 1:2

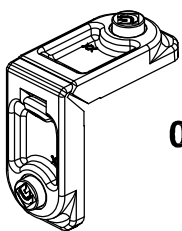

0358 combined with corner joint spacer

scale 1:1

Outil : Perceuse

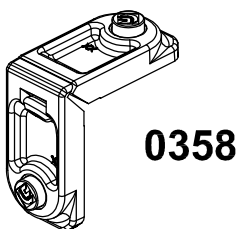
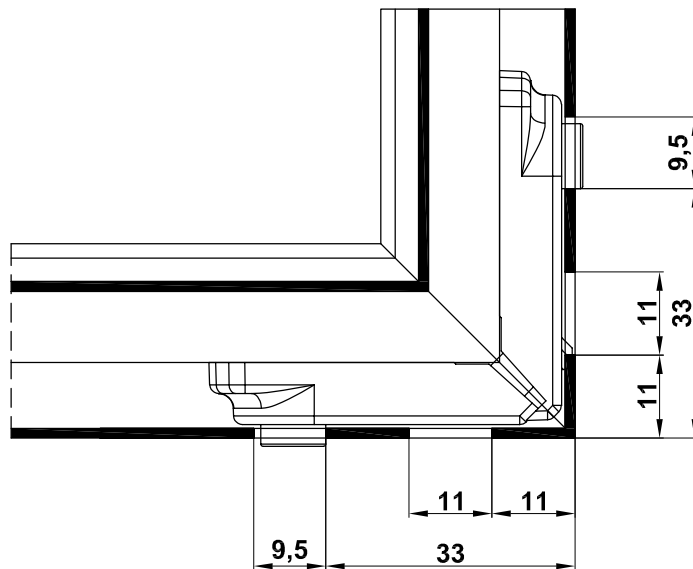
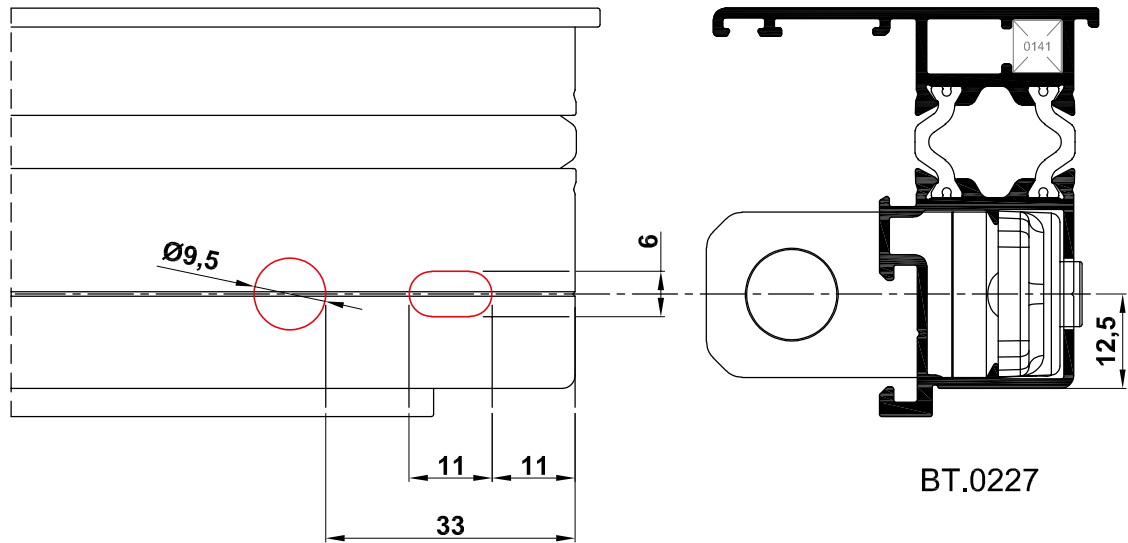

scale 1:1

Outil : Bloc outil / Perceuse

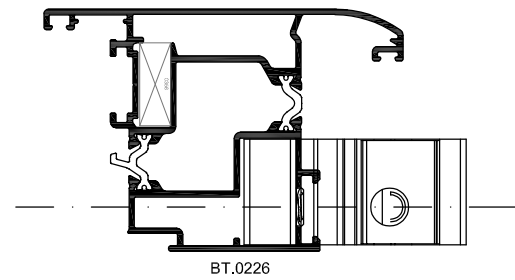
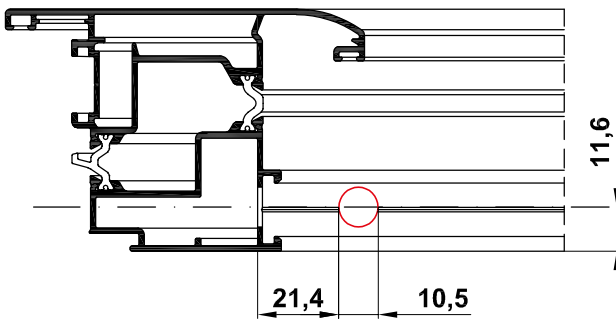
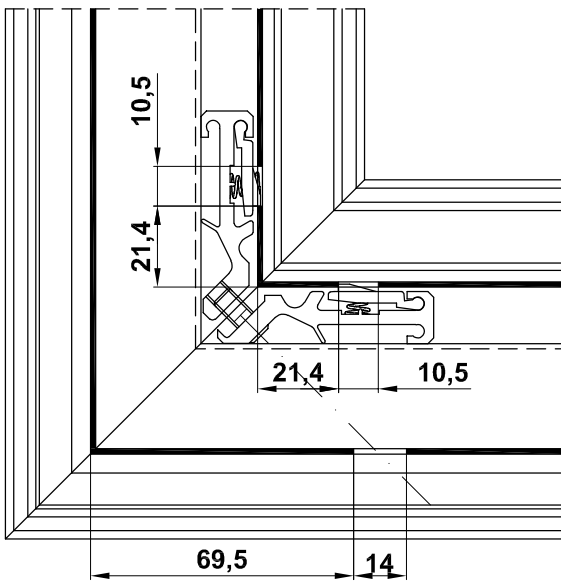
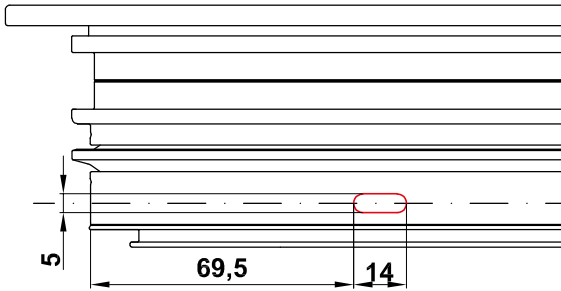

0265.50sx
0265.50dx

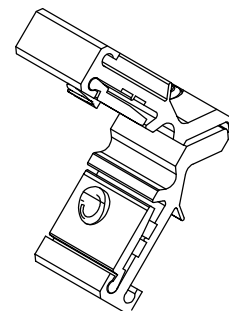

Outil : Bloc outil / Perceuse

scale 1:2

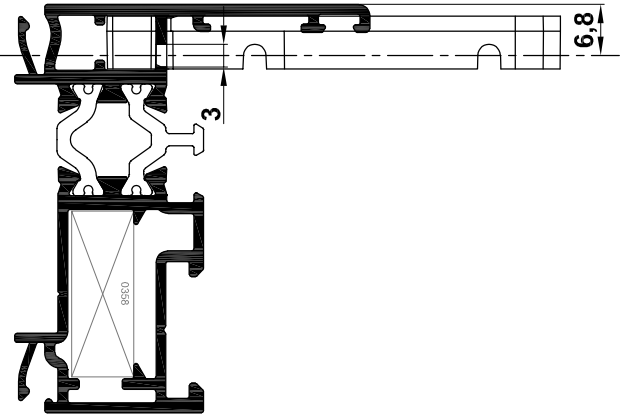
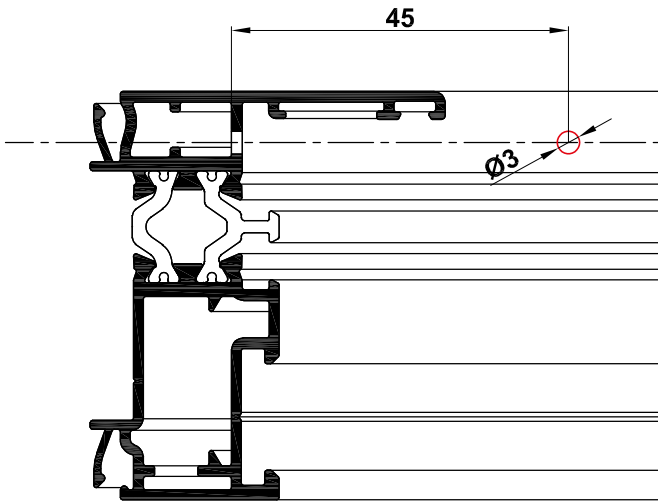

BT.0105

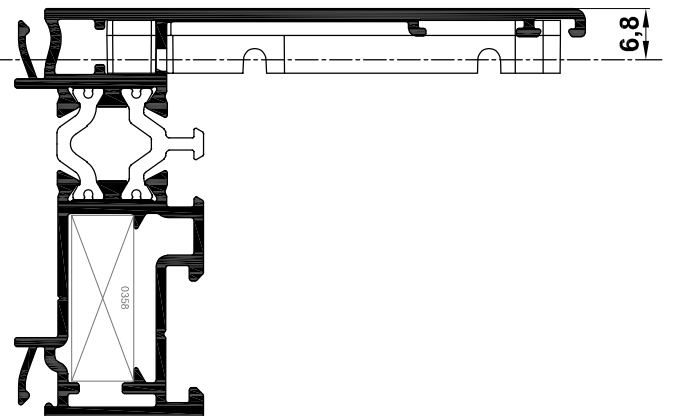
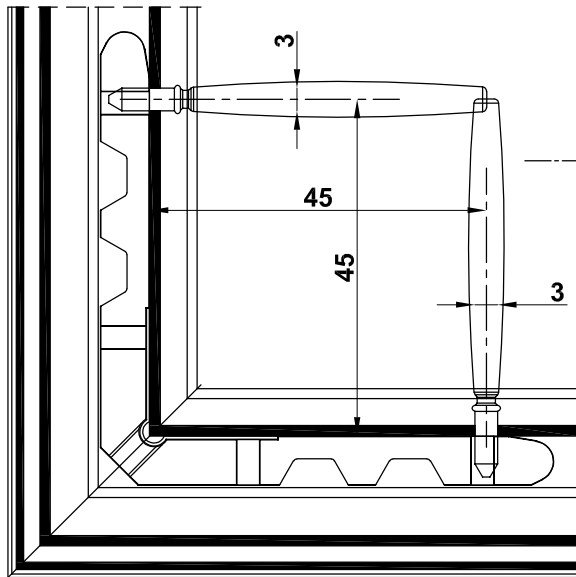

BT.0333

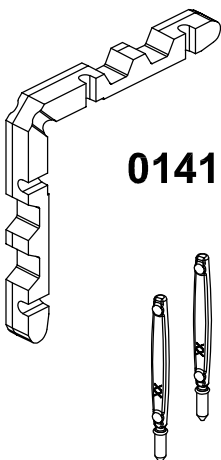

0141

0140

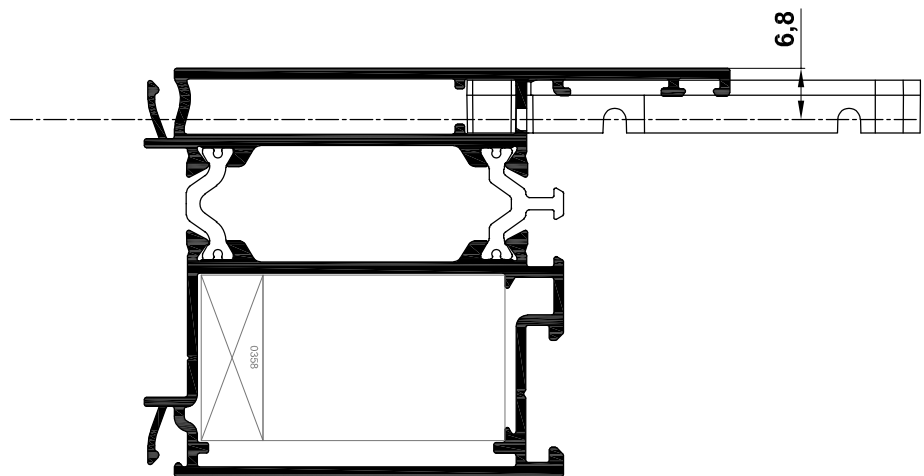

BT.0125

scale 1:1

Outil : Bloc outil / Perceuse

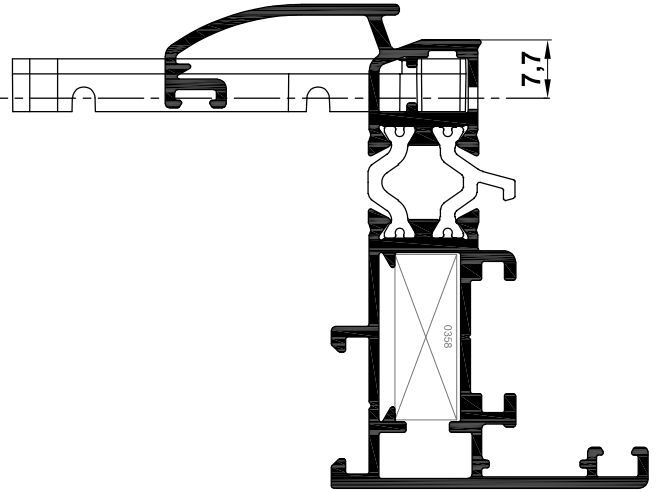
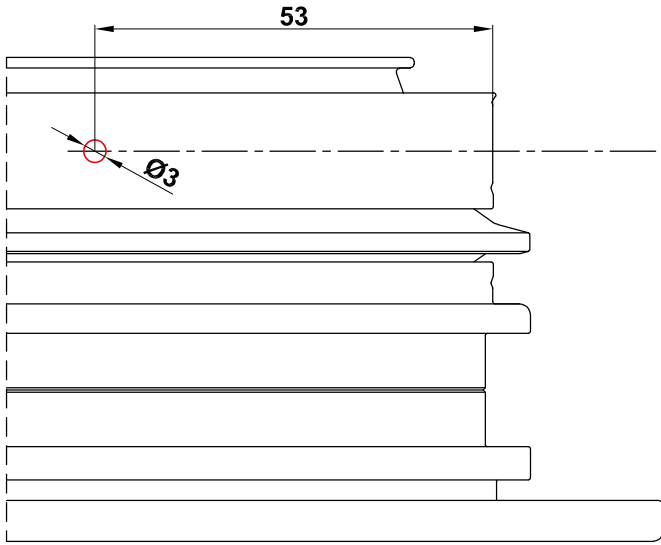

BT.0204

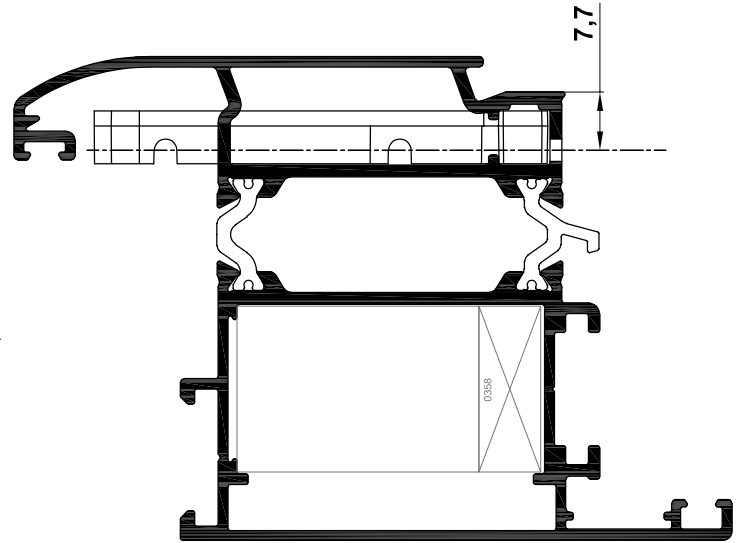
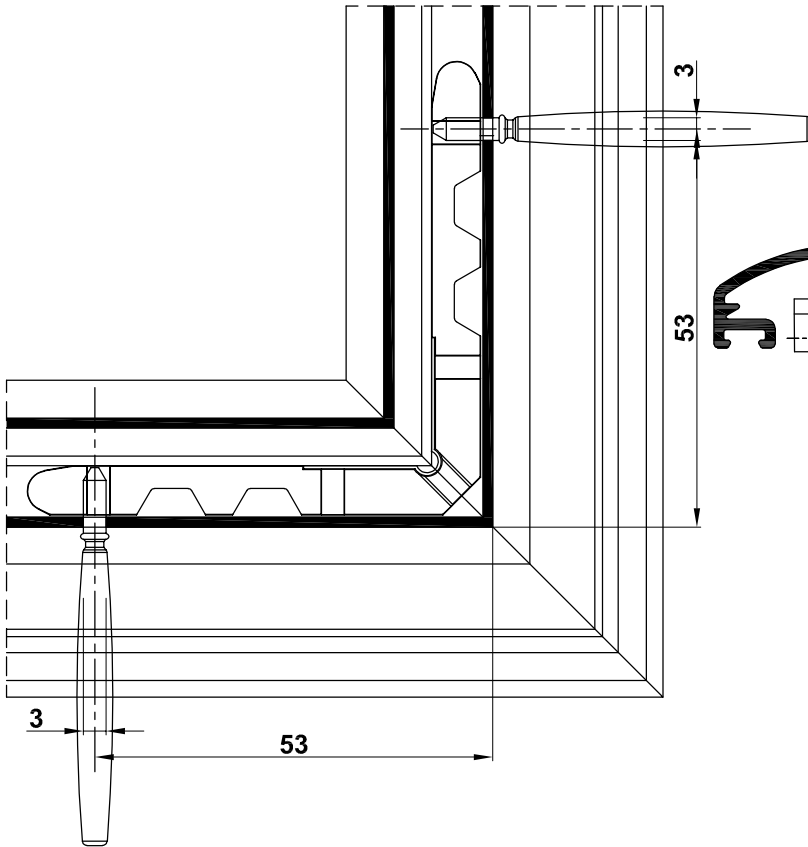

BT.0224

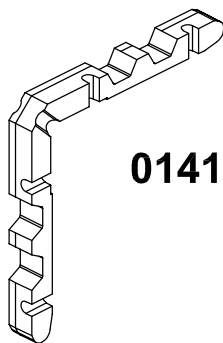

0141



0140

scale 1:1

Outil : Bloc outil / Perceuse

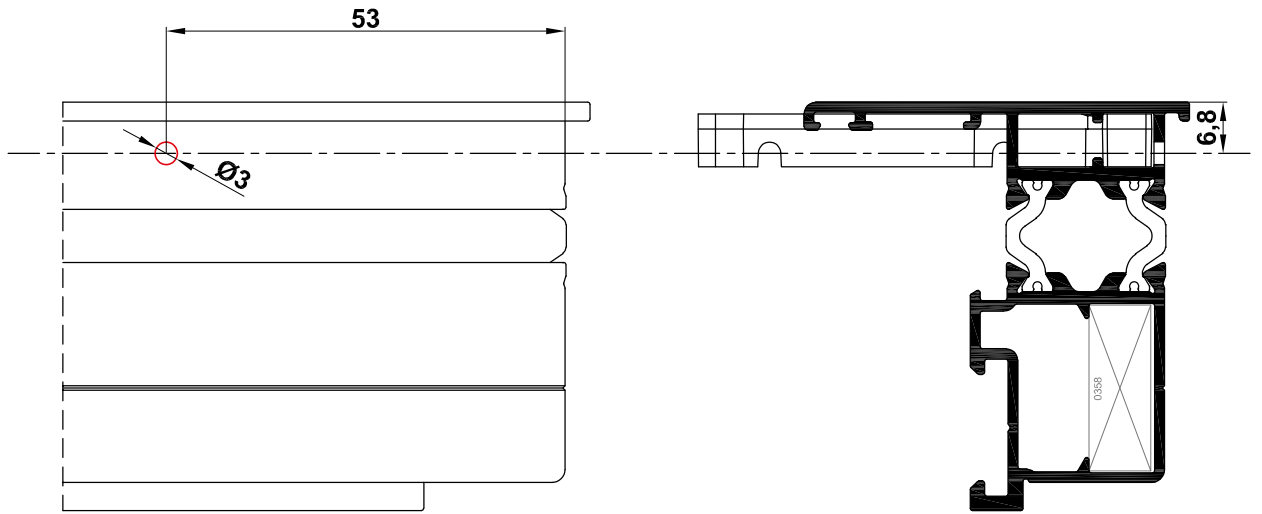

BT.0227

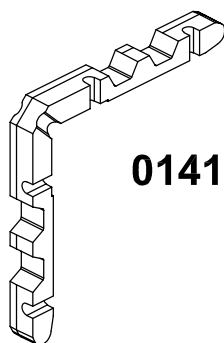
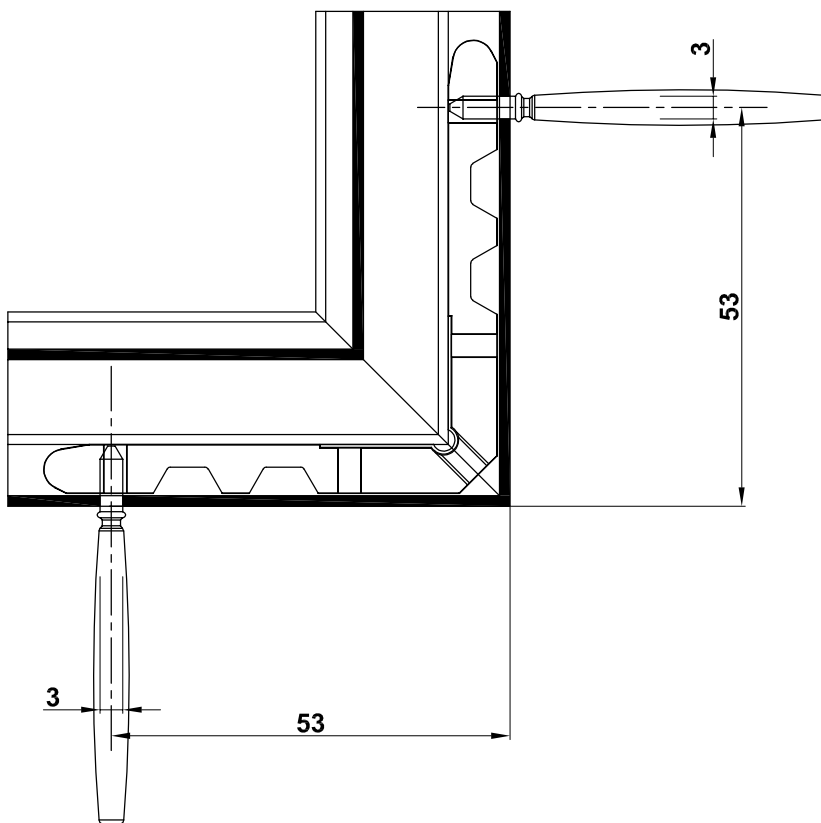

0141



0140

scale 1:1

Outil : Bloc outil / Perceuse

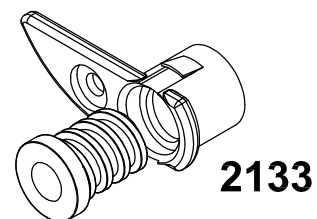
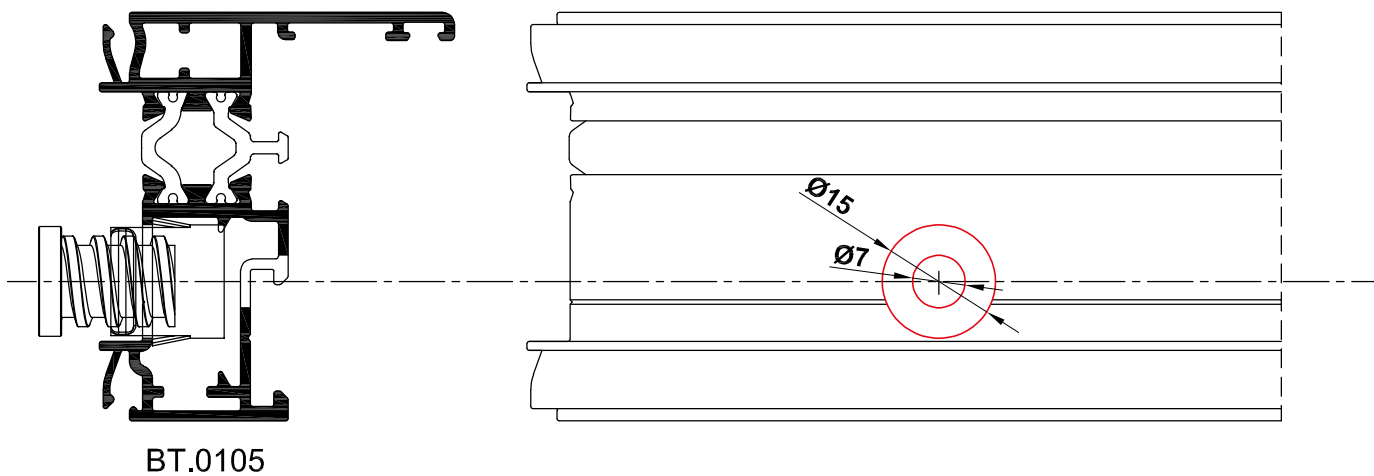

USINAGE_BUSETTE

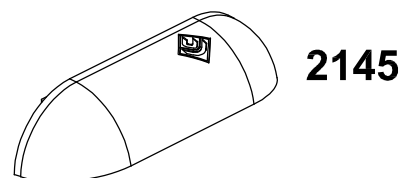
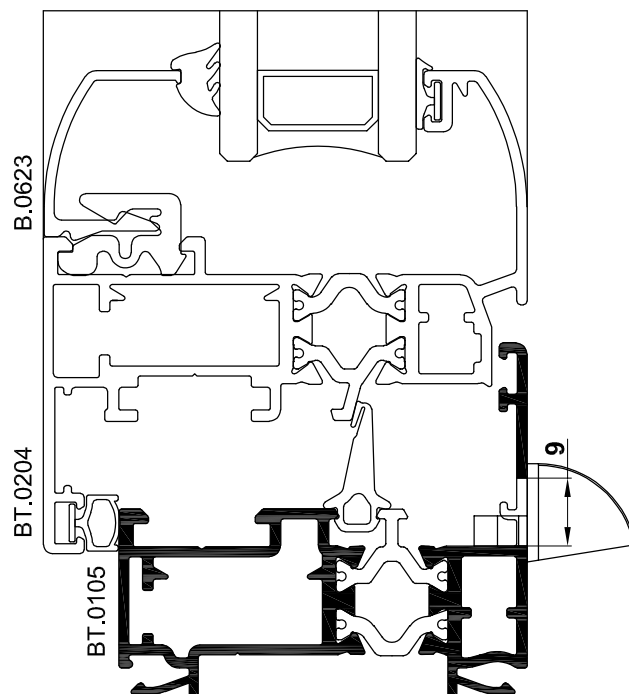
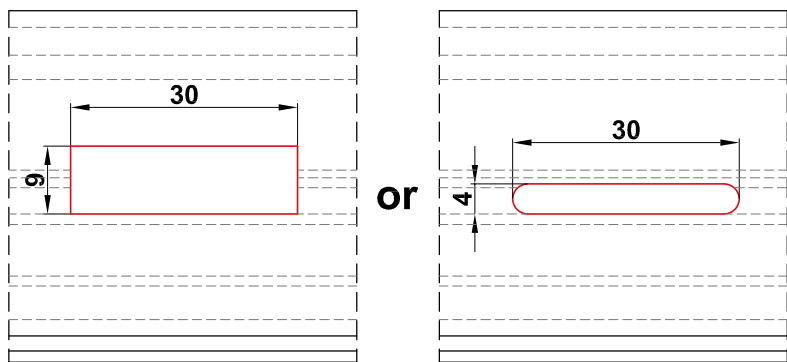

scale 1:1

ouverture battante interne

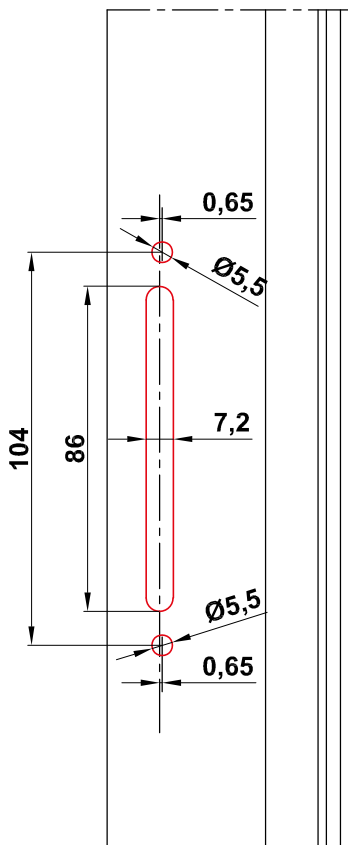
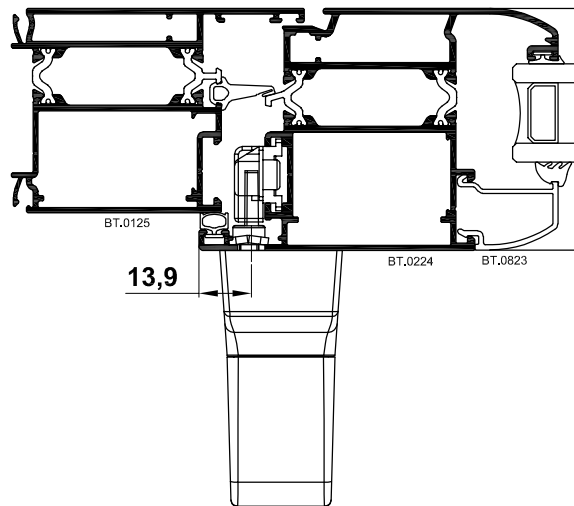
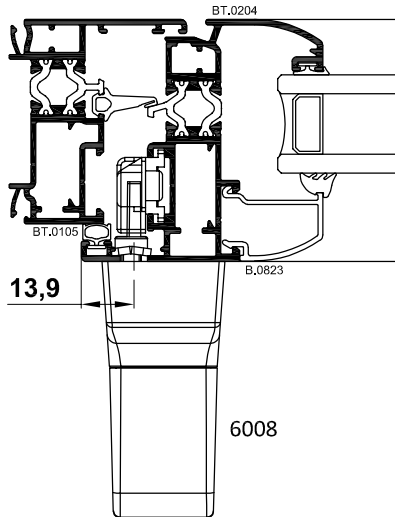

6401.1

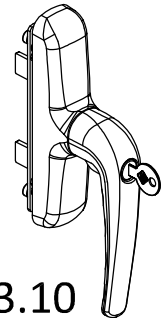
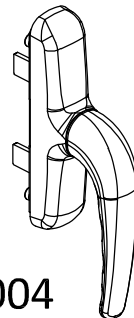

6004

6033.10

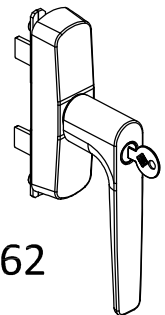
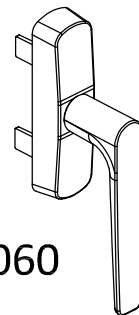

6060

6062

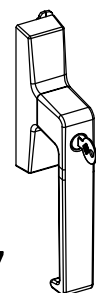
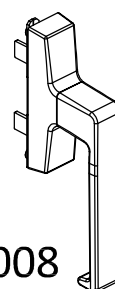
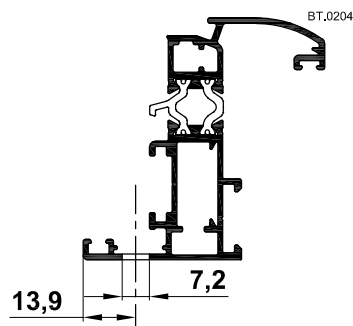

6008

6037

scale 1:2

USINAGE_BÉQUILLE À POIGNÉE



ouverture battant interne

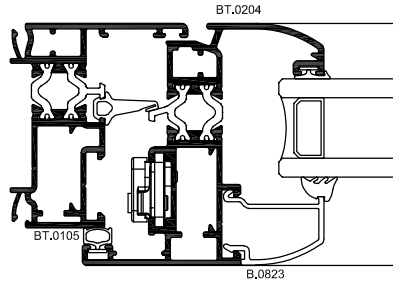
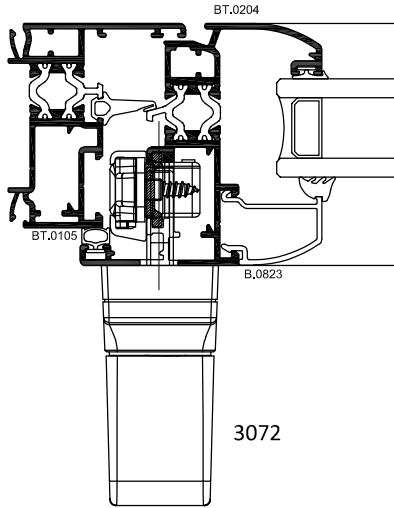

3627.20

3630.30

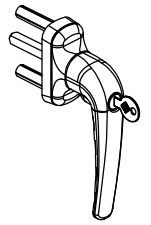
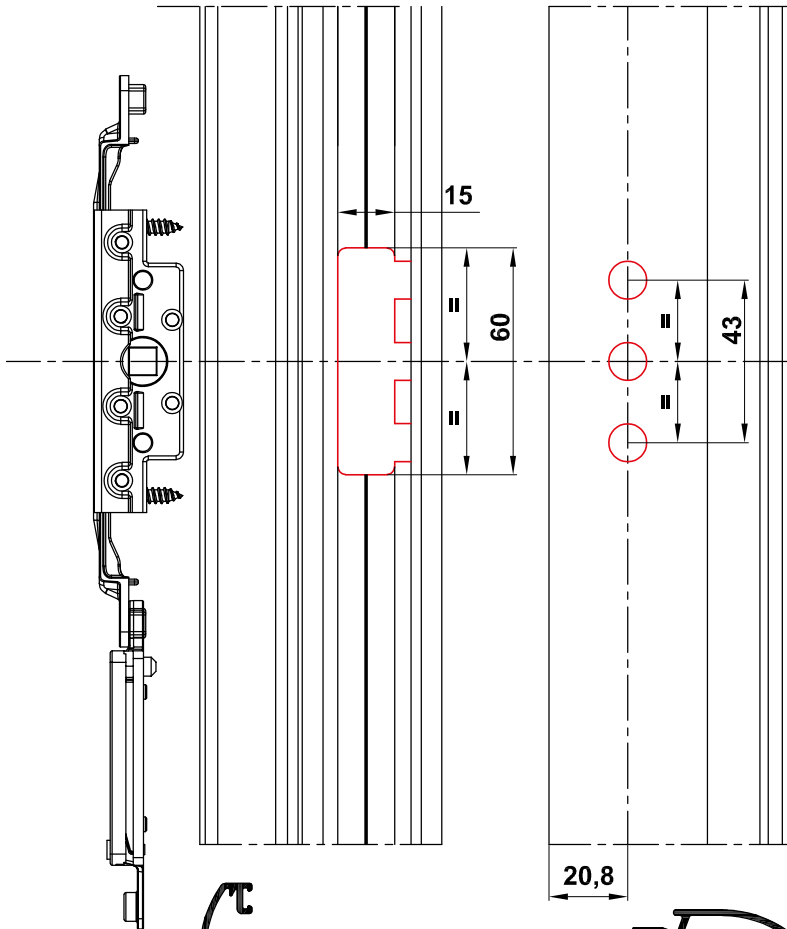

3070

3070.2

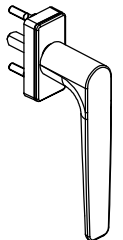
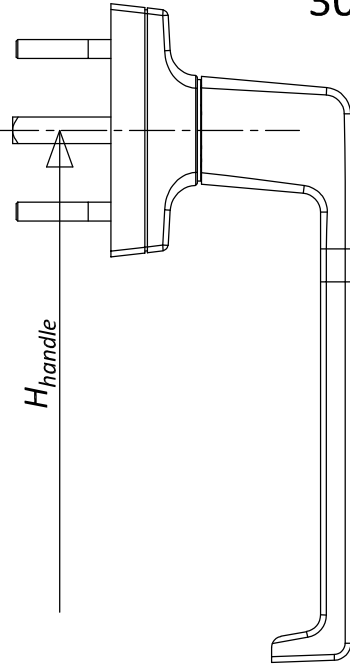

3100

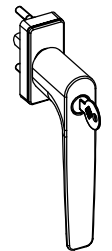

3101

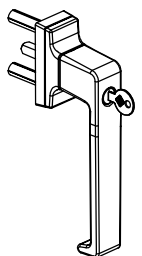
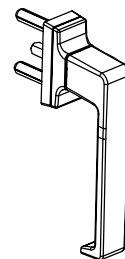
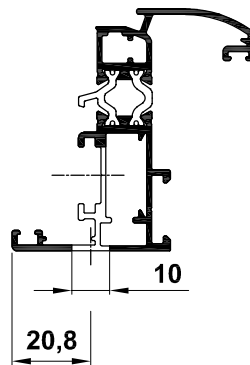
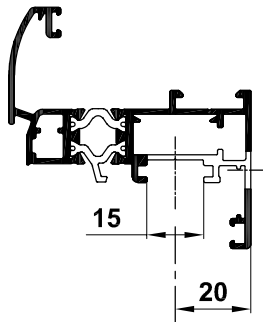

3072

3077.2

scale 1:2

USINAGE_BÉQUILLE À POIGNÉE



ouverture battante interne

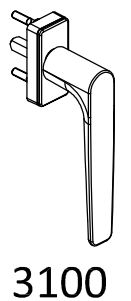
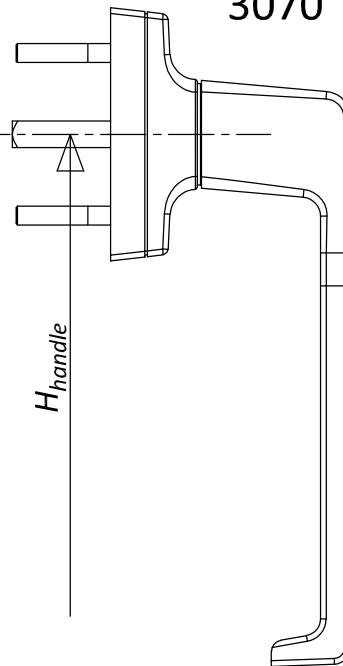
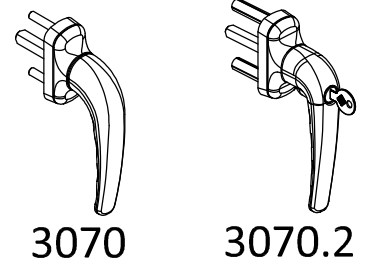
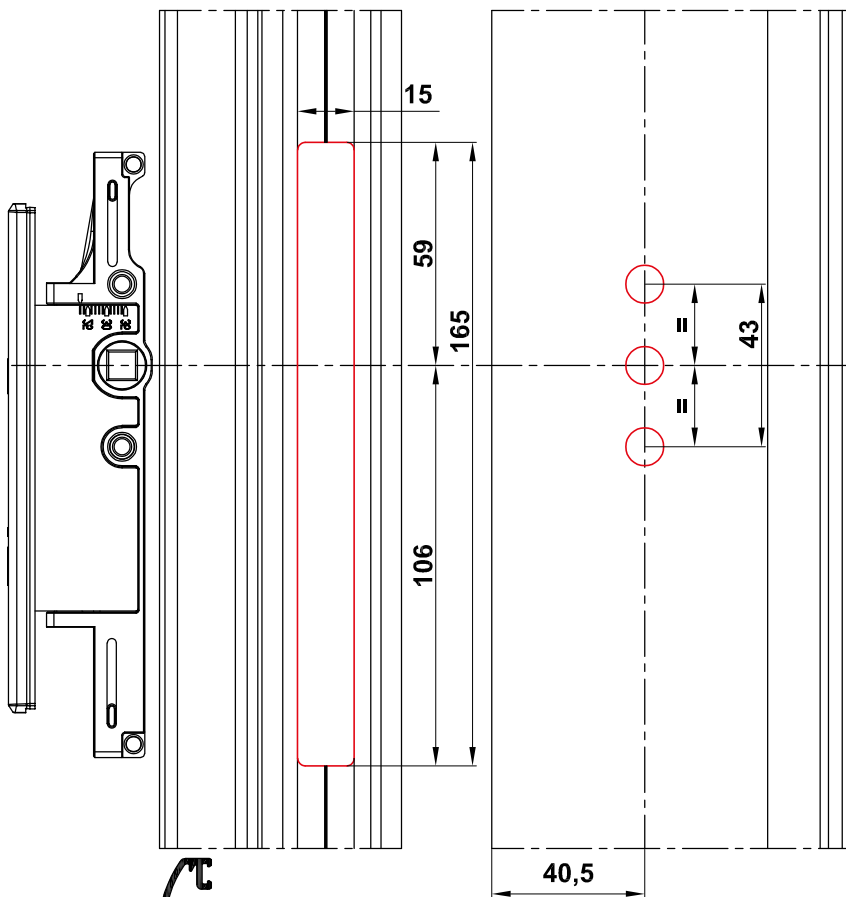
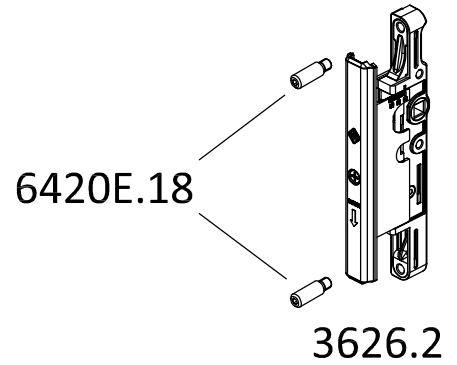
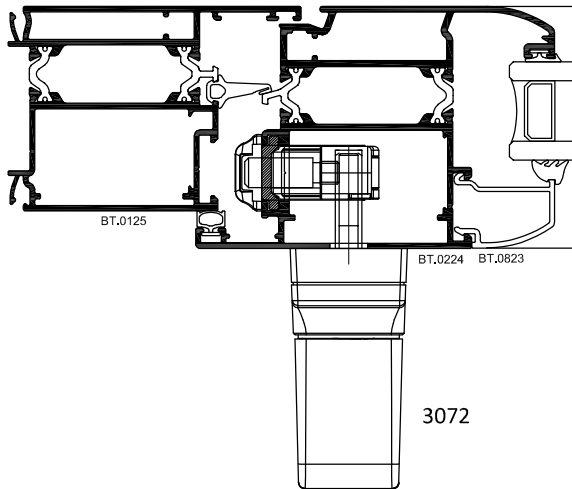

3100

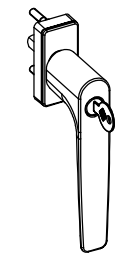

3101

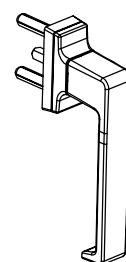
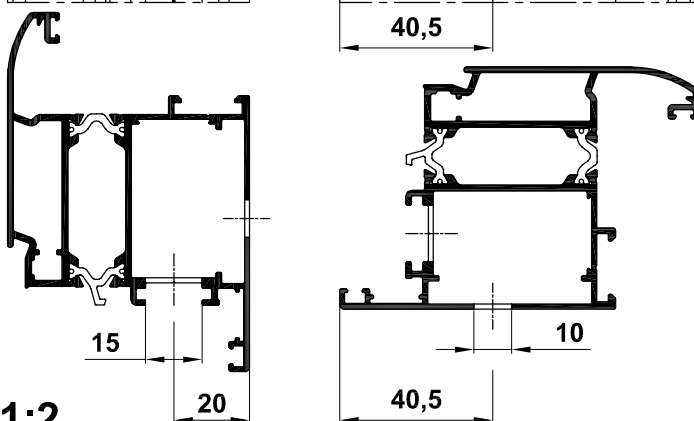

3072

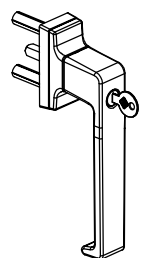

3077.2

scale 1:2

ouverture oscillo battant

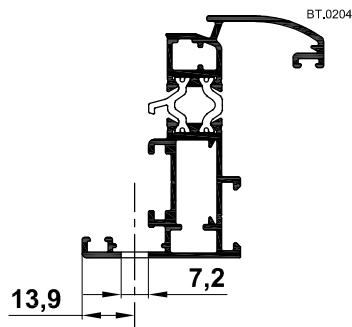
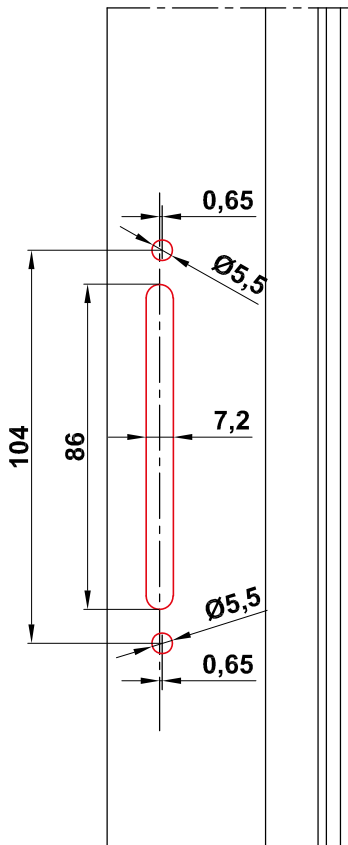
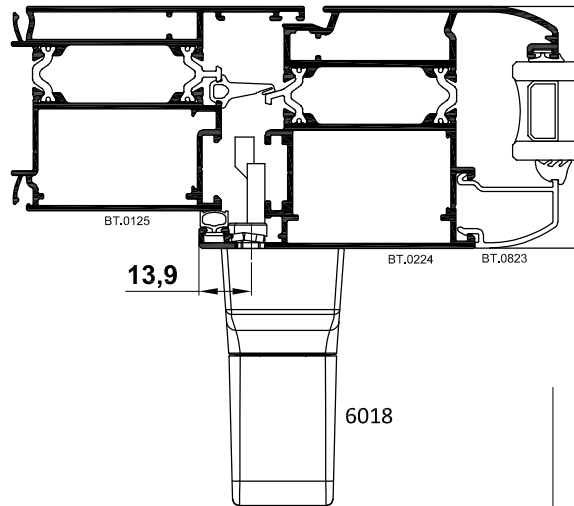
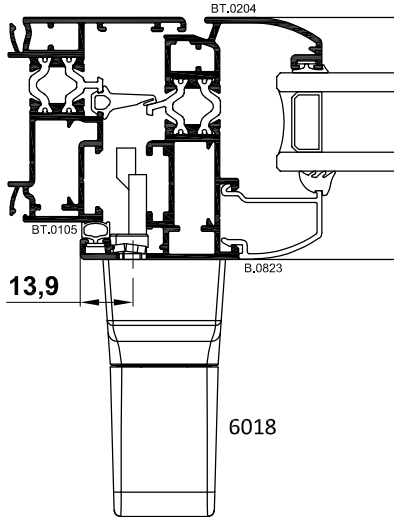

manœuvre
logique

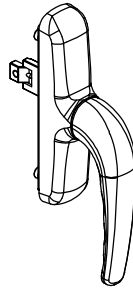
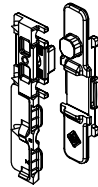

6011.10

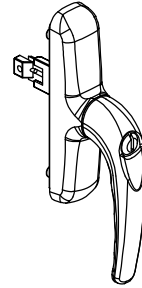

6032.10

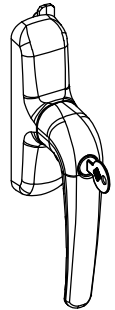

6036.20

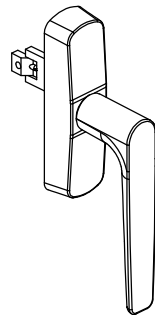

6061

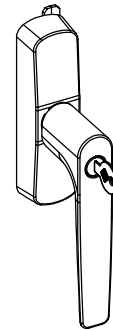

6063

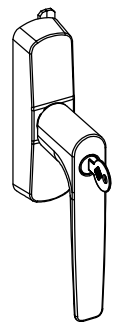

6063.20

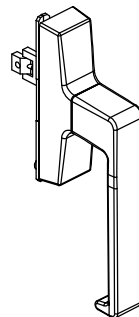

6018

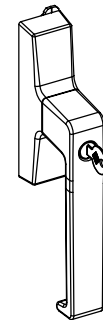

6038

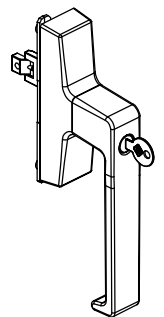

6038.20

scale 1:2

USINAGE_BÉQUILLE À POIGNÉE



ouverture oscillo battant

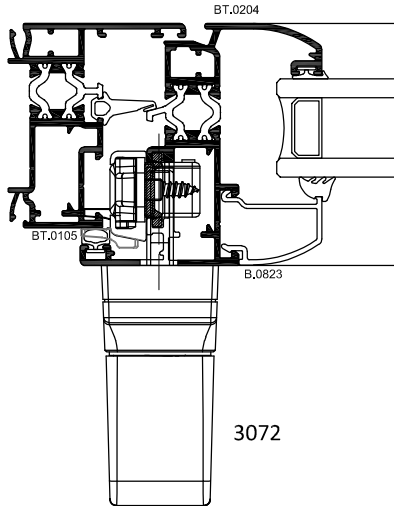

3630.20

manœuvre
logique

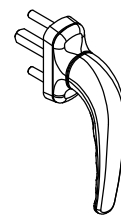
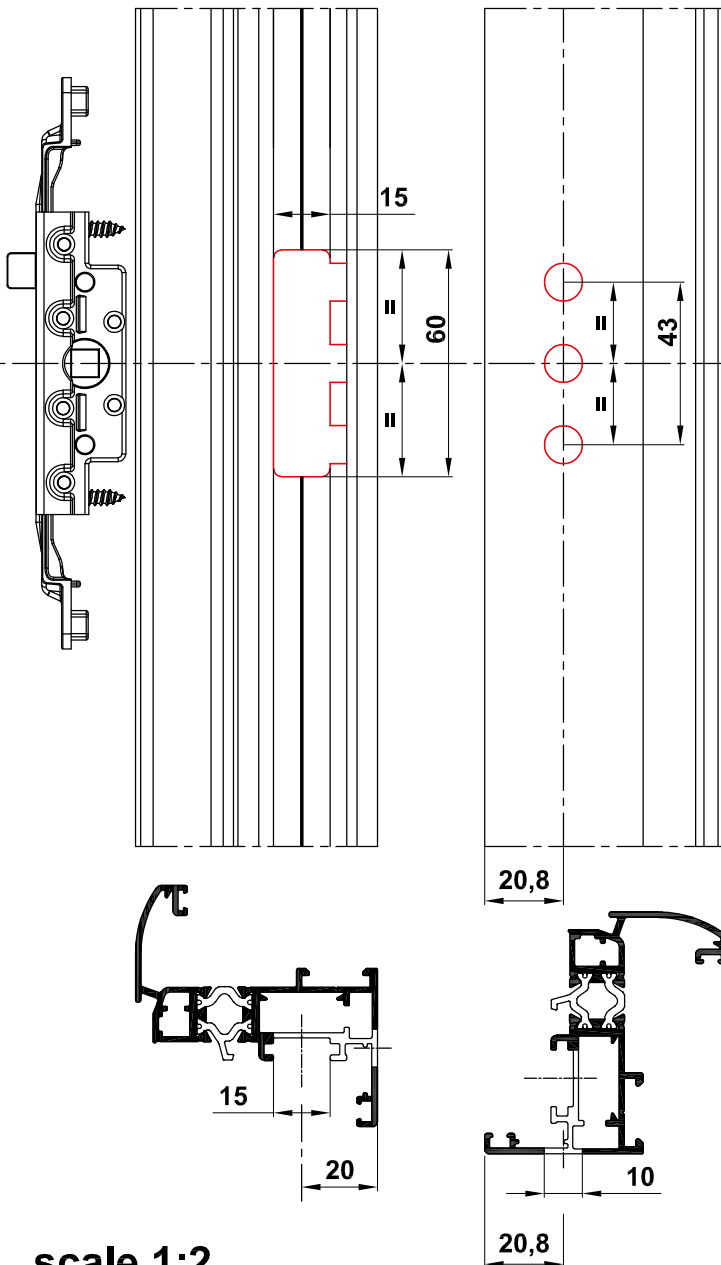

3070

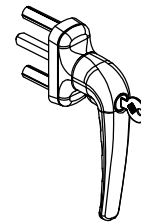

3070.2

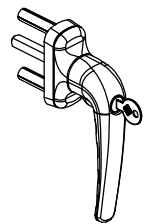

3070.25

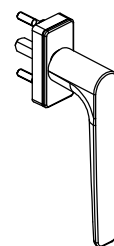

3100



3101



3101.25

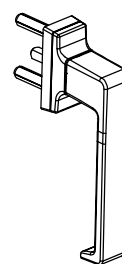

3072

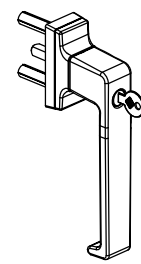

3077.2

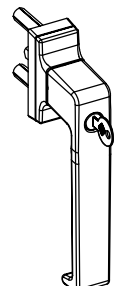

3077.25

scale 1:2

USINAGE_BÉQUILLE À POIGNÉE

ouverture oscillo battant

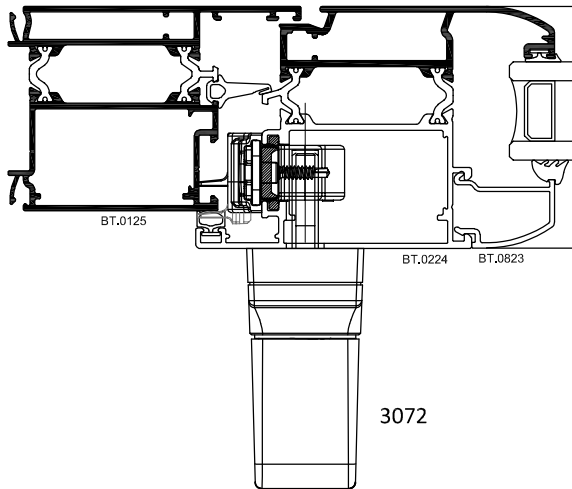

3627.2

manœuvre
logique

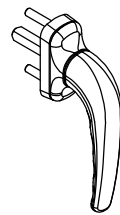
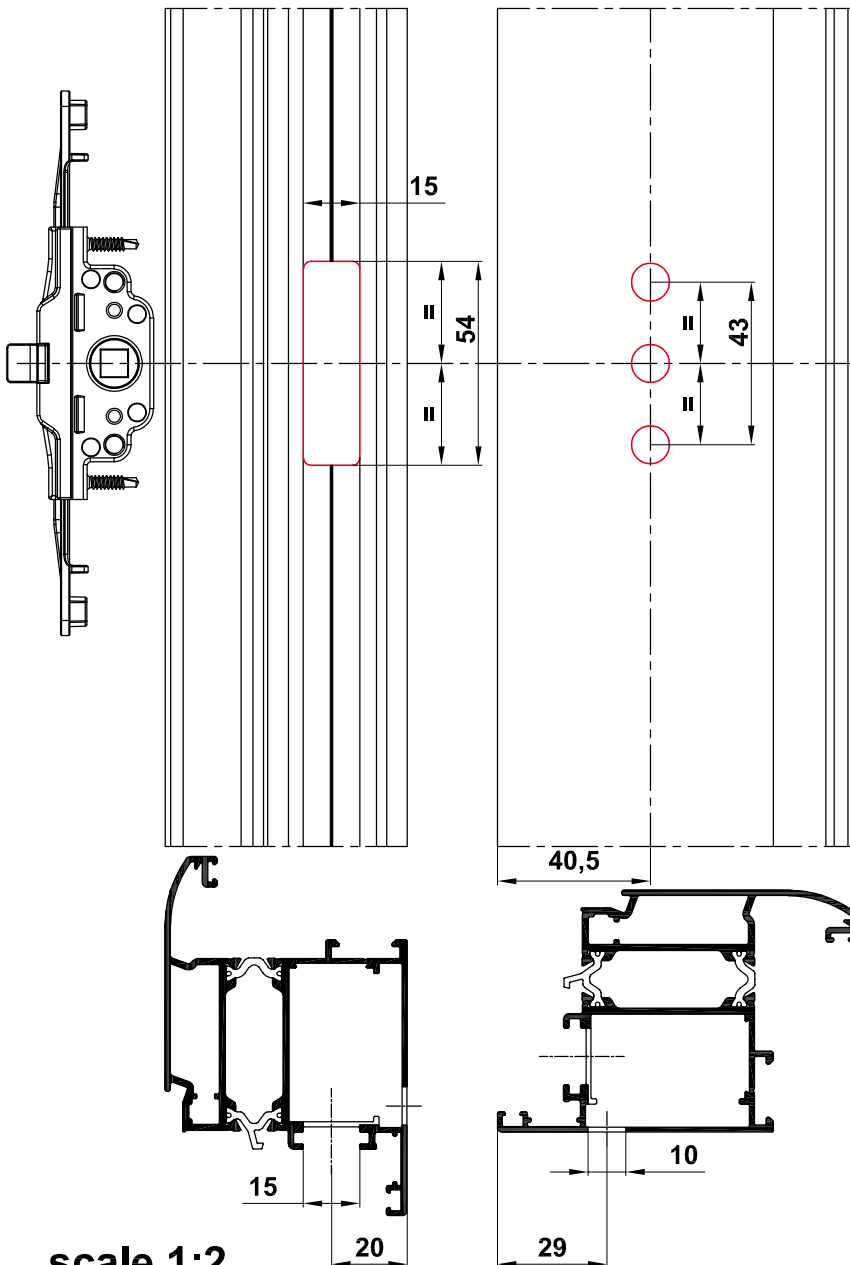

3070

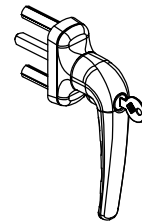

3070.2

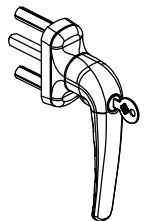

3070.25

H_{handle}

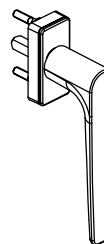

3100



3101

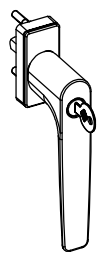

3101.25

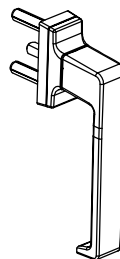

3072

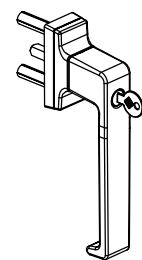

3077.2

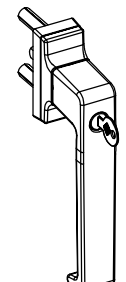

3077.25

scale 1:2

ouverture battante extérieure

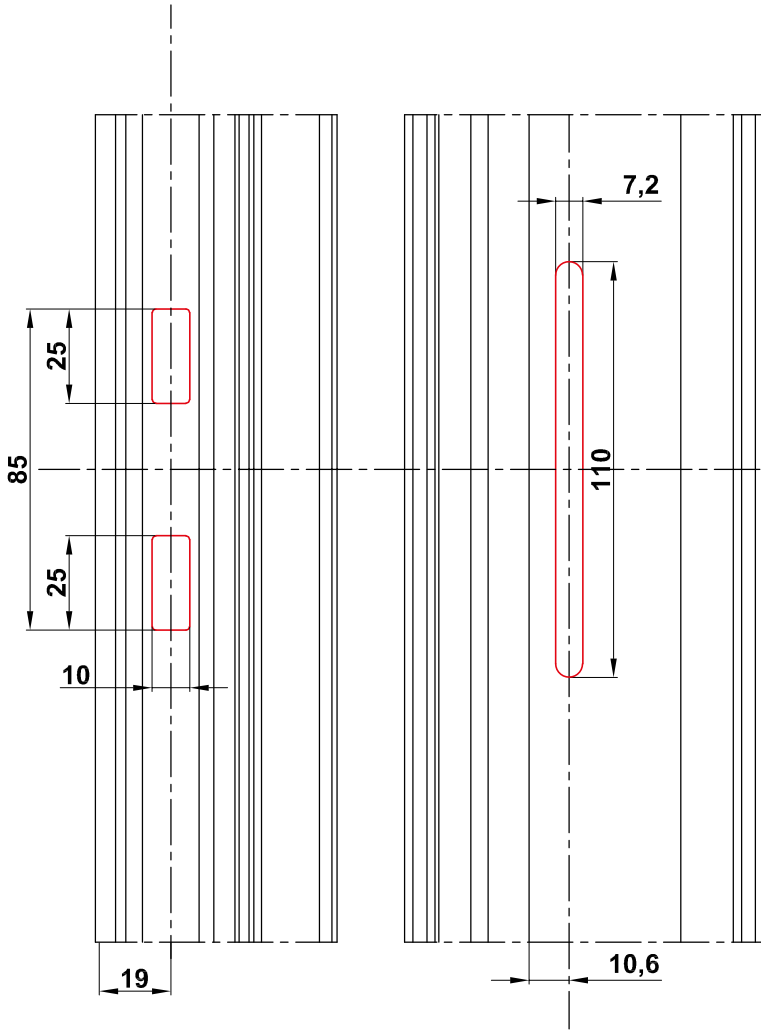
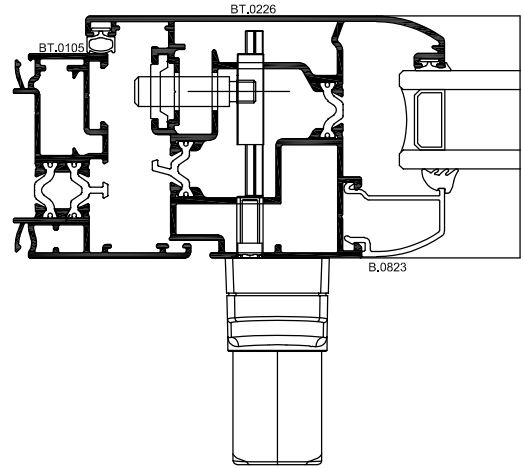

6420E.25

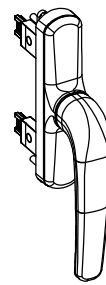
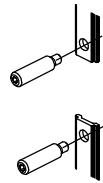

6028.3

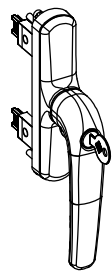

6029.3

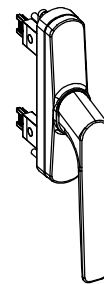

6065.3

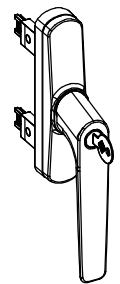

6066.3

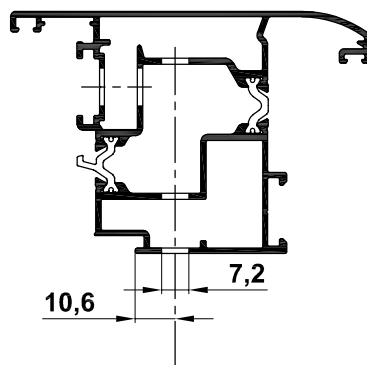
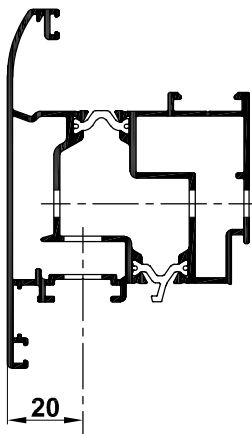

scale 1:2

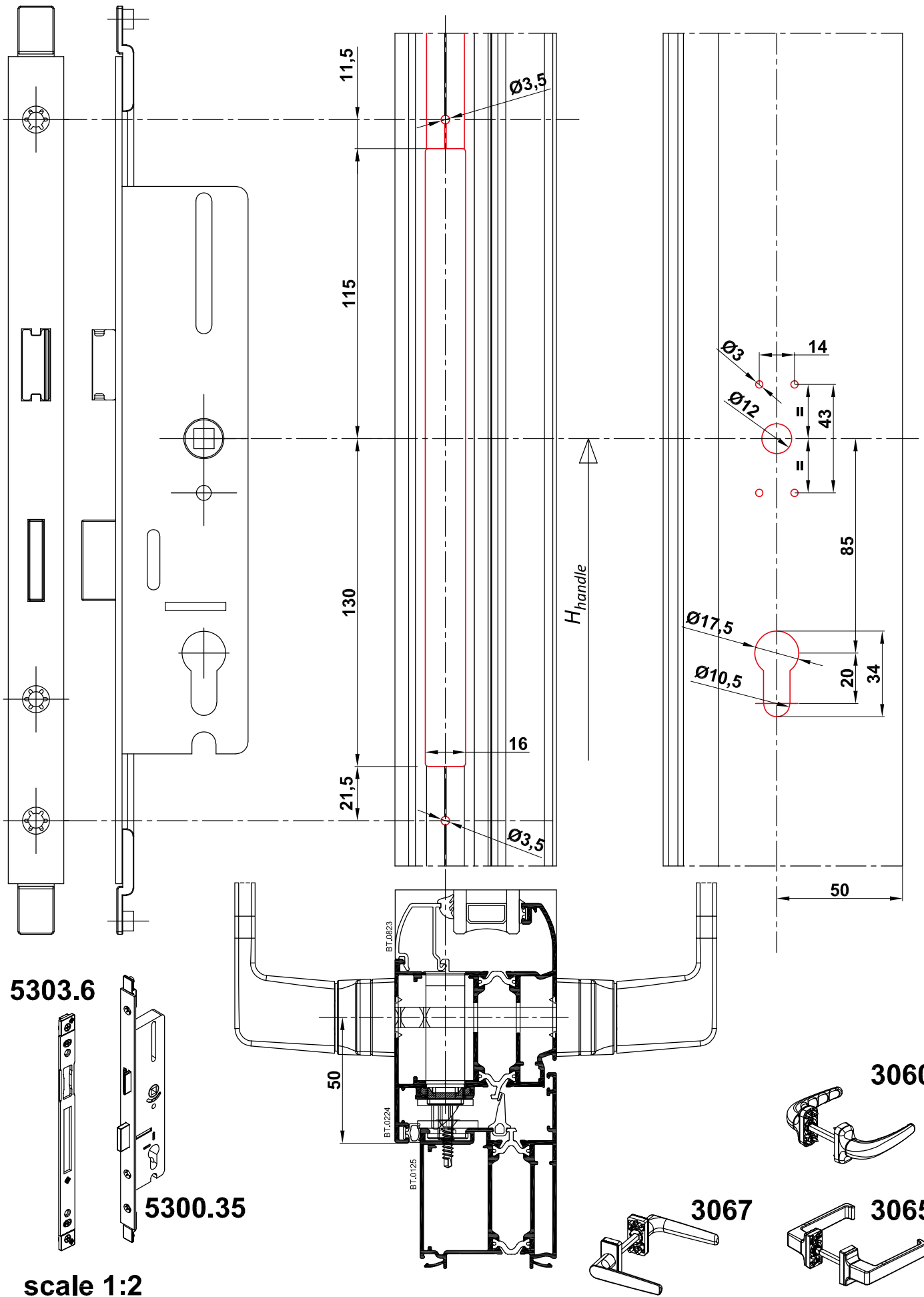

scale 1:2

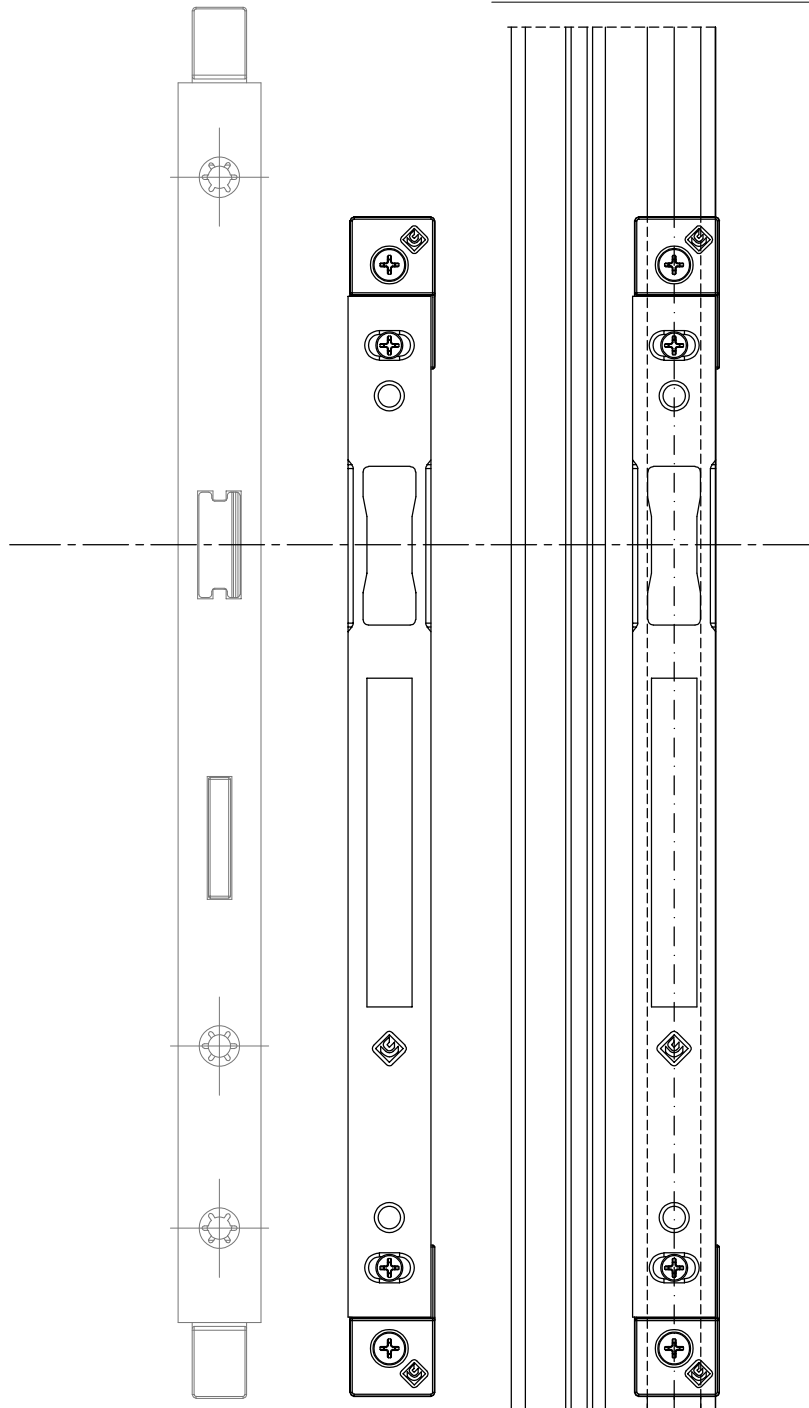

5300.35

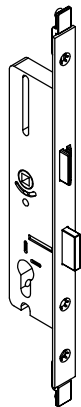

5303.6

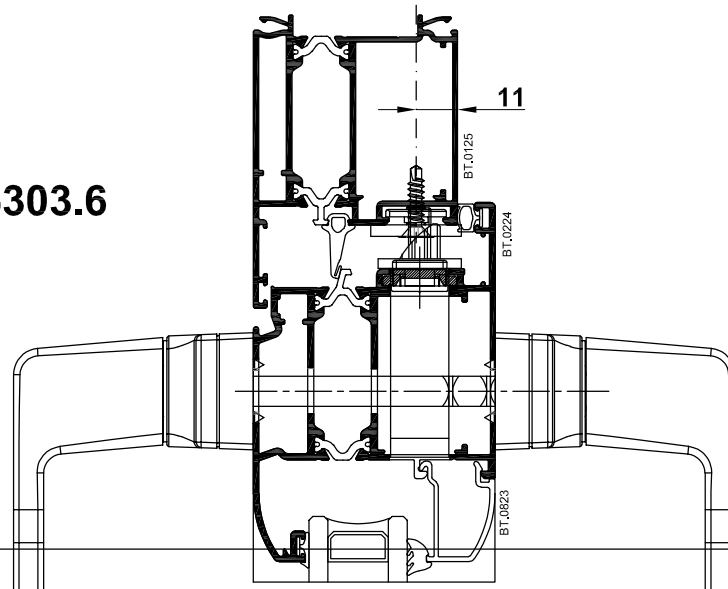

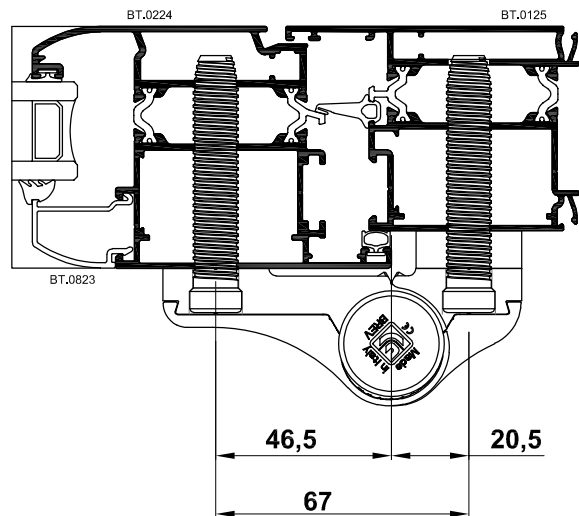
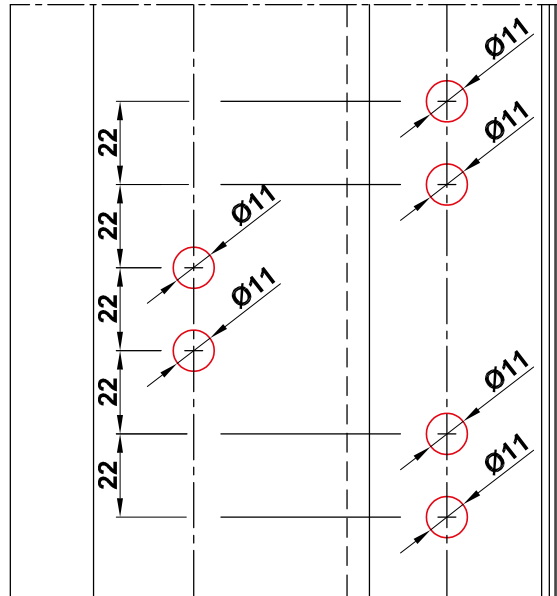
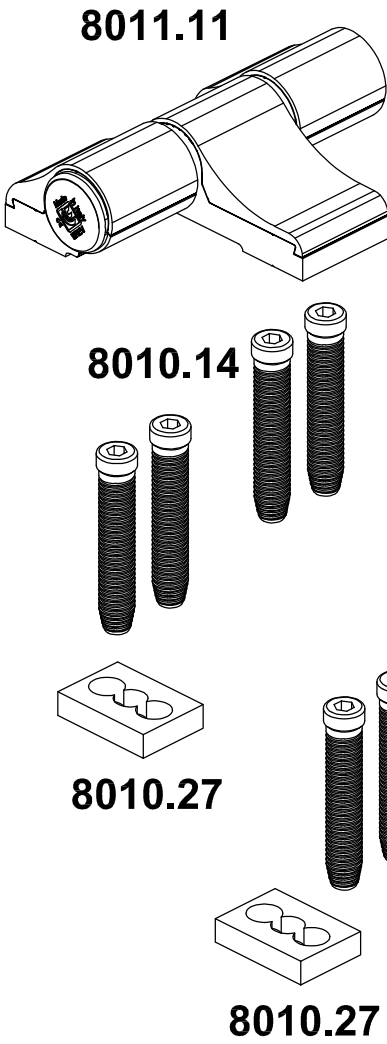
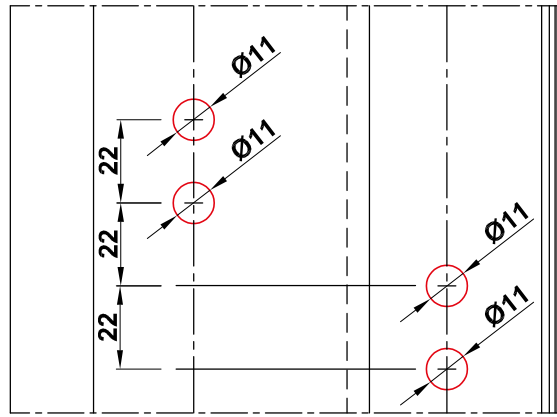
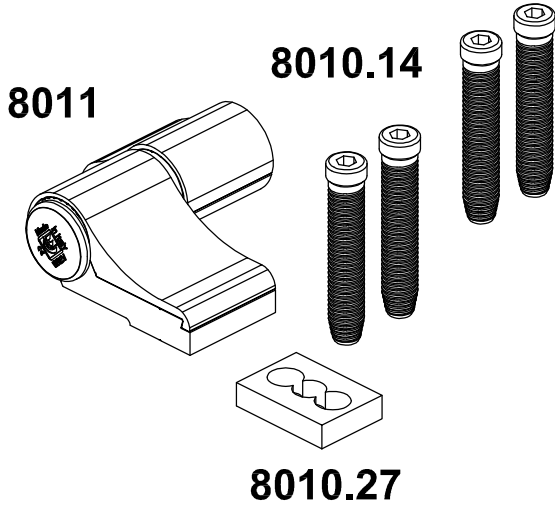

scale 1:2

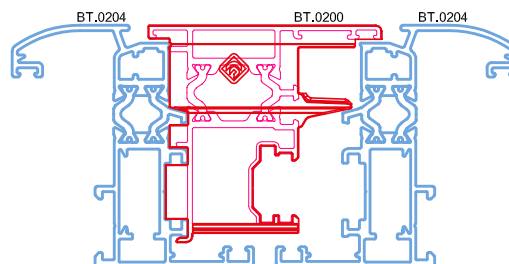
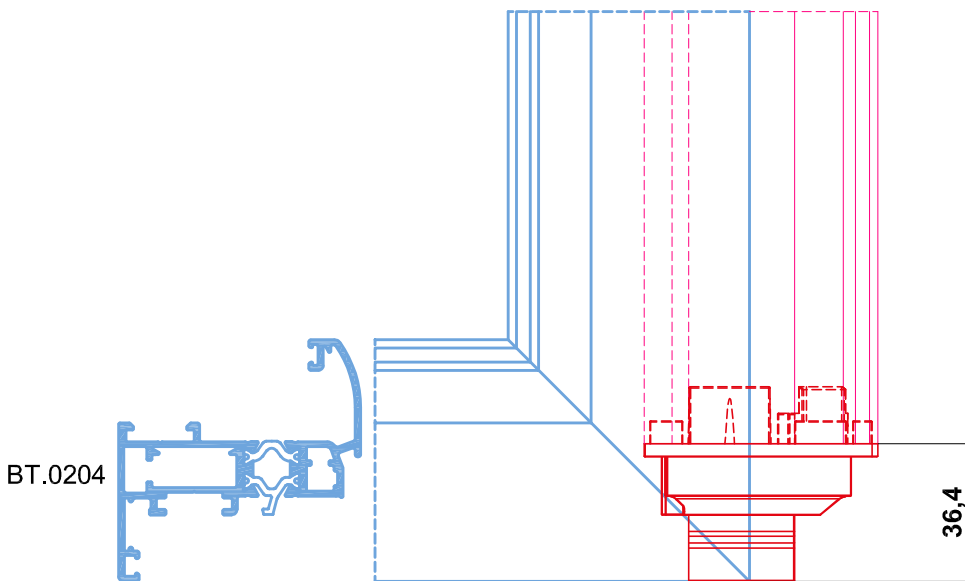
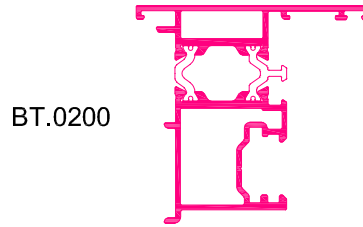
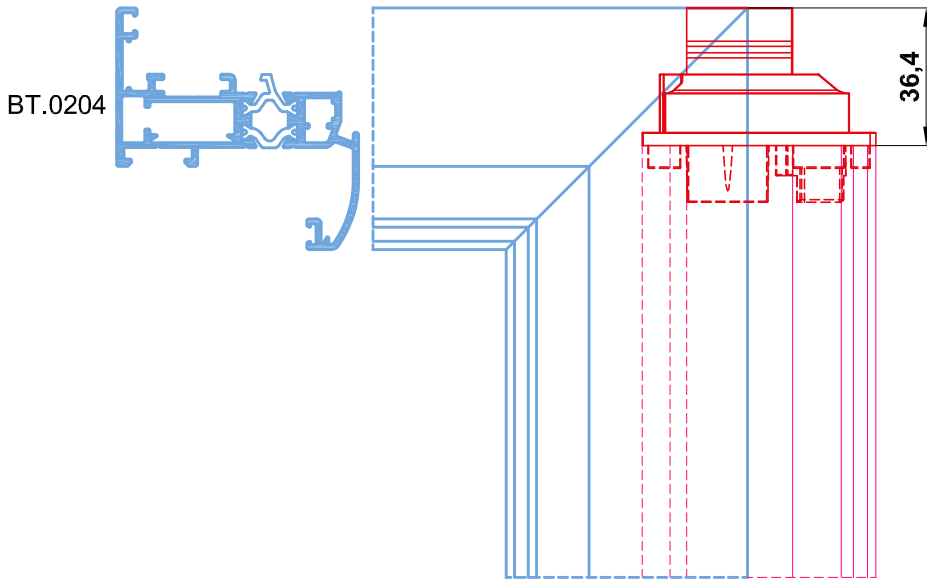

scale 1:2

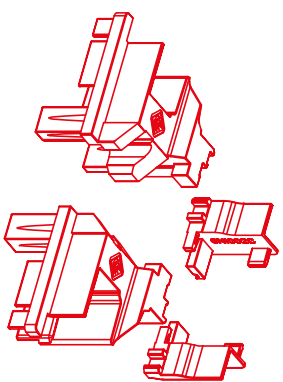

PP2081.19

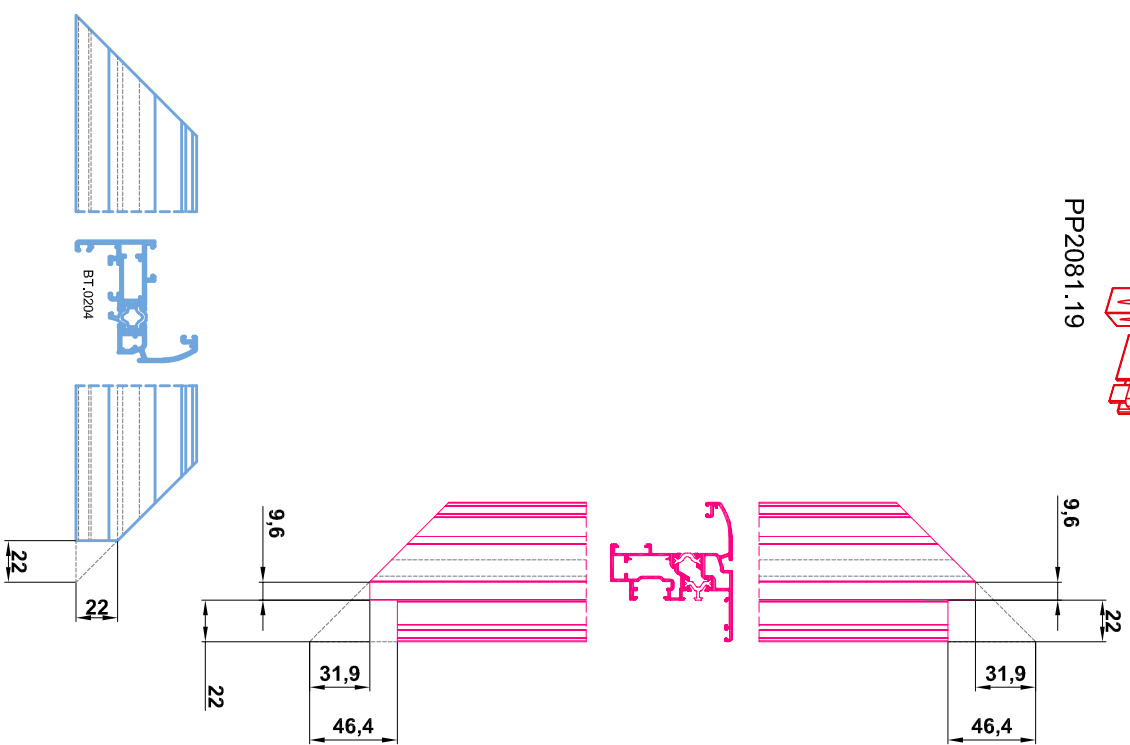

BT.0204

22

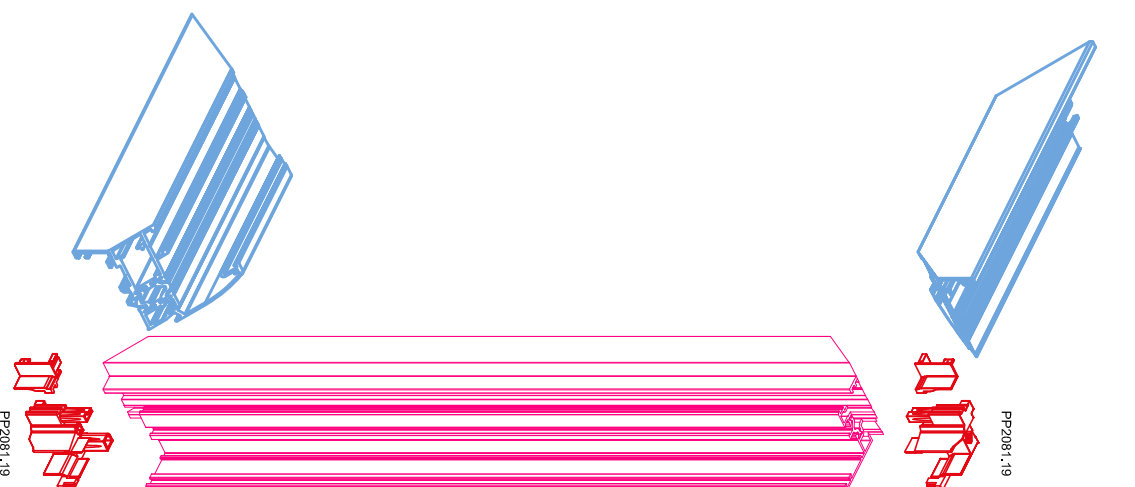

PP2081.19

PP2081.19

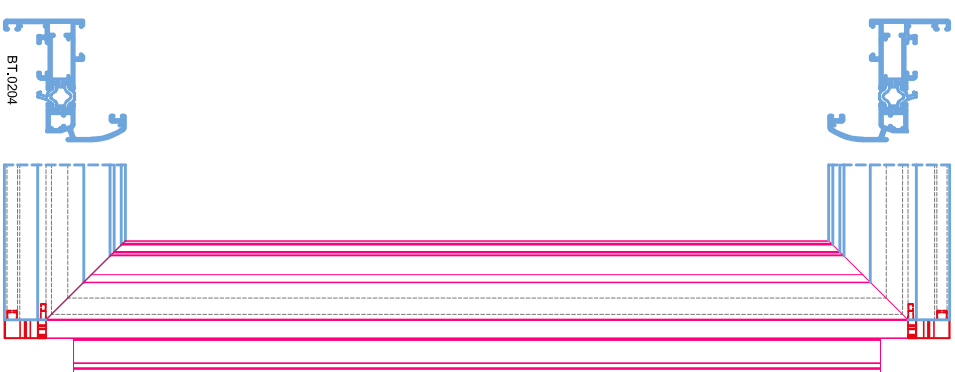

BT.0204

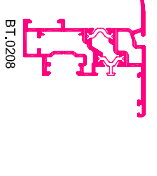

BT.0208



BT.0208

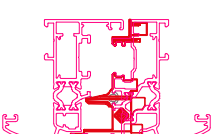

BT.0208



BT.0204

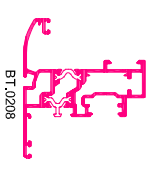

BT.0208

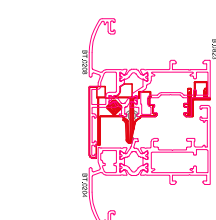

BT.0208

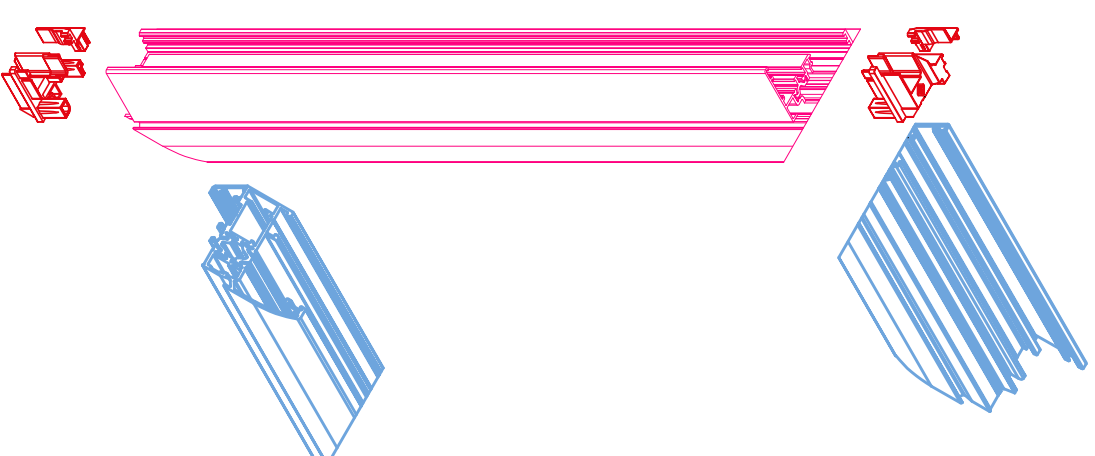

scale 1:4

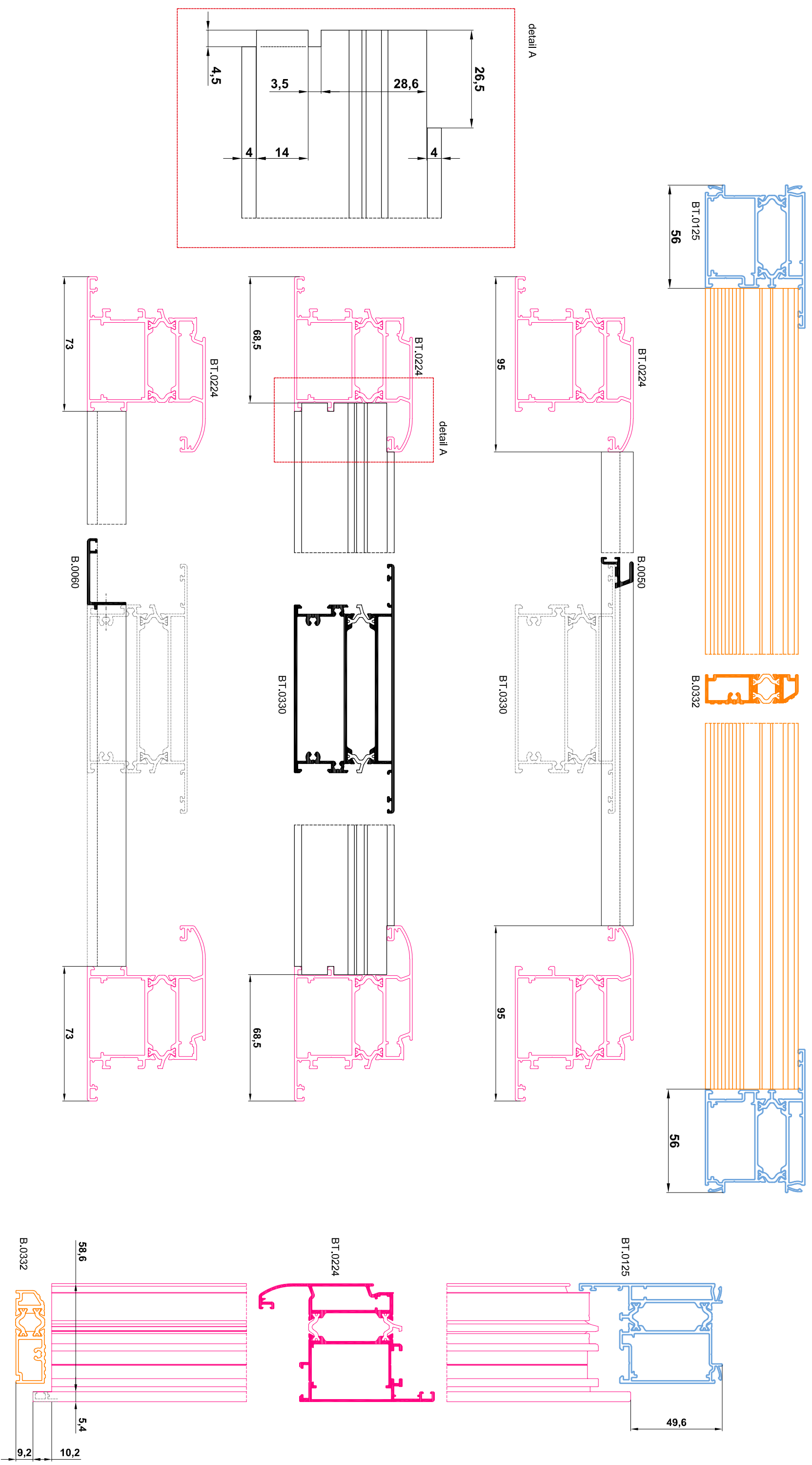

scale 1:2